



# HP Pavilion g7 Notebook PC

Maintenance and Service Guide

© Copyright 2011 Hewlett-Packard  
Development Company, L.P.

AMD, the AMD Arrow logo, Athlon, Phenom, Sempron, Turion, and combinations thereof, are trademarks of Advanced Micro Devices, Inc. Bluetooth is a trademark owned by its proprietor and used by Hewlett-Packard Company under license. Intel, Celeron, Core, and Pentium are trademarks of Intel Corporation in the U.S. and other countries. Microsoft and Windows are U.S. registered trademarks of Microsoft Corporation. SD Logo is a trademark of its proprietor.

The information contained herein is subject to change without notice. The only warranties for HP products and services are set forth in the express warranty statements accompanying such products and services. Nothing herein should be construed as constituting an additional warranty. HP shall not be liable for technical or editorial errors or omissions contained herein.

Second Edition: May 2011

Document Part Number: 635956-002

## Safety warning notice

---

**⚠ WARNING!** To reduce the possibility of heat-related injuries or of overheating the device, do not place the device directly on your lap or obstruct the device air vents. Use the device only on a hard, flat surface. Do not allow another hard surface, such as an adjoining optional printer, or a soft surface, such as pillows or rugs or clothing, to block airflow. Also, do not allow the AC adapter to contact the skin or a soft surface, such as pillows or rugs or clothing, during operation. The device and the AC adapter comply with the user-accessible surface temperature limits defined by the International Standard for Safety of Information Technology Equipment (IEC 60950).

---



---

# Table of contents

<b>1 Product description .....</b>	<b>1</b>
<b>2 External component identification .....</b>	<b>9</b>
Top .....	10
Button .....	10
Keys .....	11
Lights .....	12
TouchPad .....	13
Display .....	14
Front .....	15
Left side .....	15
Right side .....	16
Bottom .....	17
<b>3 Illustrated parts catalog .....</b>	<b>18</b>
Service tag .....	18
Computer major components .....	19
Cable Kit .....	27
Display assembly subcomponents .....	28
Mass storage devices .....	30
Miscellaneous parts .....	31
Sequential part number listing .....	32
<b>4 Removal and replacement procedures .....</b>	<b>41</b>
Preliminary replacement requirements .....	41
Tools required .....	41
Service considerations .....	41
Plastic parts .....	41
Cables and connectors .....	41
Drive handling .....	42
Grounding guidelines .....	42

Electrostatic discharge damage .....	42
Packaging and transporting guidelines .....	44
Component replacement procedures .....	46
Service tag .....	46
Computer feet .....	47
Battery .....	47
Optical drive .....	49
Hard drive .....	51
RTC battery .....	53
Memory module .....	54
WLAN module .....	55
Keyboard .....	57
Top cover .....	61
Power button board .....	64
TouchPad button board .....	66
TouchPad LED board .....	67
Bluetooth module .....	69
Speakers .....	71
LED board .....	72
USB board .....	74
Power connector cable .....	75
System board .....	77
Optical drive cable .....	81
Fan and heat sink .....	83
Processor .....	90
Display assembly .....	93
<b>5 Setup Utility (BIOS) and System Diagnostics .....</b>	<b>101</b>
Using Setup Utility .....	101
Starting Setup Utility .....	101
Changing the language of Setup Utility .....	101
Navigating and selecting in Setup Utility .....	102
Displaying system information .....	102
Restoring factory settings in Setup Utility .....	103
Exiting Setup Utility .....	103
Updating the BIOS .....	103
Determining the BIOS version .....	104
Downloading a BIOS update .....	104
Using System Diagnostics .....	105

<b>6 Specifications .....</b>	<b>106</b>
Computer specifications .....	106
17.3-inch display specifications .....	107
Hard drive specifications .....	108
<b>7 Backup and recovery .....</b>	<b>109</b>
Restore .....	109
Creating restore media .....	110
Performing a system restore .....	111
Restoring using the dedicated recovery partition (select models only) .....	111
Restoring using the restore media .....	112
Changing the computer boot order .....	112
Backing up and recovering your information .....	113
Using Windows Backup and Restore .....	114
Using Windows system restore points .....	114
When to create restore points .....	114
Create a system restore point .....	115
Restore to a previous date and time .....	115
<b>8 Power cord set requirements .....</b>	<b>116</b>
Requirements for all countries .....	116
Requirements for specific countries and regions .....	117
<b>9 Recycling .....</b>	<b>118</b>
Battery .....	118
Display .....	118
<b>Index .....</b>	<b>124</b>





# 1 Product description

Category	Description	Computer models equipped with an AMD processor	Computer models equipped with an Intel processor
<b>Product Name</b>	HP Pavilion g7 Notebook PC	√	√
<b>Processors</b>	AMD Fusion E-450 1.65-GHz processor (dual core, 18 W)	√	
	AMD A8-3500M 2.40-GHz processor (1.5-GHz FSB, 4.0-MB L2 cache, quad core, 35 W)	√	
	AMD A6-3400M 2.30-GHz processor (1.4-GHz FSB, 4.0-MB L2 cache, quad core, 35 W)	√	
	AMD A4-3300M 2.50-GHz processor (1.9-GHz FSB, 4.0-MB L2 cache, dual core, 35 W)	√	
	AMD Athlon II P360 2.30-GHz processor (1.0-MB L2 cache, 1066-MHz, 3.2GT/sec, dual core, 25 W)	√	
	AMD Athlon II P340 2.20-GHz processor (1.0-MB L2 cache, 1066-MHz, 3.2GT/sec, dual core, 25 W)	√	
	AMD Phenom II N870 2.30-GHz processor (1.5-MB L2 cache, 1333-MHz, 3.6GT/sec, triple core, 35 W)	√	
	AMD Phenom II N970 2.20-GHz processor (2.0-MB L2 cache, 1333-MHz, 3.6GT/sec, quad core, 35 W)	√	
	AMD Phenom II P860 2.00-GHz processor (1.5-MB L2 cache, 1333-MHz, 3.6GT/sec, triple core, 25 W)	√	
	AMD Phenom II N660 3.00-GHz processor (2.0-MB L2 cache, 1333-MHz, 3.6GT/sec, dual core, 35 W)	√	
	AMD Phenom II N850 2.20-GHz processor (1.5-MB L2 cache, 1333-MHz, 3.6GT/sec, triple core, 35 W)	√	

<b>Category</b>	<b>Description</b>	<b>Computer models equipped with an AMD processor</b>	<b>Computer models equipped with an Intel processor</b>
	AMD Phenom II P650 2.60-GHz processor (2.0-MB L2 cache, 1066-MHz, 3.6GT/sec, triple core, 25 W)	√	
	AMD Phenom II P960 1.80-GHz processor (2.0-MB L2 cache, 1066-MHz, 3.6GT/sec, quad core, 25 W)	√	
	AMD Turion II P560 2.50-GHz processor (2.0-MB L2 cache, 1066-MHz, 3.6GT/sec, dual core, 25 W)	√	
	AMD V160 2.40-GHz processor (512-KB L2 cache, 1066-MHz 3.2-GT/sec, single core, 25 W)	√	
	AMD V140 2.30-GHz processor (512-KB L2 cache, 1066-MHz 3.2-GT/sec, single core, 25 W)	√	
	Intel Core i7-2620M 2.70-GHz (SC turbo up to 3.40-GHz) processor (4.0-MB L3 cache, dual core, 35 W)		√
	Intel Core i5-2540M 2.60-GHz (SC turbo up to 3.30-GHz) processor (3.0-MB L3 cache, dual core, 35 W)		√
	Intel Core i5-2520M 2.50-GHz (SC turbo up to 3.20-GHz) processor (3.0-MB L3 cache, dual core, 35 W)		√
	Intel Core i5-2430M 2.40-GHz (SC turbo up to 3.00-GHz) processor (3.0-MB L3 cache, dual core, 35 W)		√
	Intel Core i5-2410M 2.30-GHz (SC turbo up to 2.90-GHz) processor (3.0-MB L3 cache, dual core, 35 W)		√
	Intel Core i5-480M 2.66-GHz (SC turbo up to 2.93-GHz) processor (3.0-MB L3 cache, dual core, 35 W)		√
	Intel Core i3-2350M 2.30-GHz processor (3.0-MB L3 cache, dual core, 35 W)		√
	Intel Core i3-2330M 2.20-GHz processor (3.0-MB L3 cache, dual core, 35 W)		√
	Intel Core i3-2310M 2.10-GHz processor (3.0-MB L3 cache, dual core, 35 W)		√
	Intel Core i3-390M 2.66-GHz processor (3.0-MB L3 cache, dual core, 35 W)		√
	Intel Core i3-380M 2.53-GHz processor (3.0-MB L3 cache, dual core, 35 W)		√

Category	Description	Computer models equipped with an AMD processor	Computer models equipped with an Intel processor
	Intel Core i3-370M 2.40-GHz processor (3.0-MB L3 cache, dual core, 35 W)		√
	Intel Pentium B950 TJ85 2.10-GHz processor (2.0-MB L3 cache, dual core 35 W)		√
	Intel Pentium B940 TJ85 2.00-GHz processor (2.0-MB L3 cache, dual core 35 W)		√
	Intel Pentium P6200 2.13-GHz processor (3.0-MB L3 cache, dual core, 35 W)		√
	Intel Pentium P6300 2.26-GHz processor (3.0-MB L3 cache, dual core, 35 W)		√
<b>Chipset</b>	Northbridge: AMD A60M Fusion controller hub	√	
	Northbridge: AMD RS880MD		
	Southbridge: AMD SB820M		
	Intel® HM65 and HM55 Express chipset		√
<b>Graphics</b>	<b>Internal graphics:</b>	√	
	<ul style="list-style-type: none"> <li>• AMD Radeon™ HD 6620M graphics supporting HD decode, DX11, and HDMI on computer models equipped with an AMD A8-3500M processor</li> <li>• AMD Radeon HD 6520M graphics supporting HD decode, DX11, and HDMI on computer models equipped with an AMD A6-3400M processor</li> <li>• AMD Radeon HD 6480M graphics supporting HD decode, DX11, and HDMI on computer models equipped with an AMD A4-3300M processor</li> <li>• AMD Radeon HD 4250 graphics supporting DX10.1 on computer models equipped with an AMD Athlon, Phenom, Turion, or V-series processor</li> </ul>		
	<b>Internal graphics:</b>		√
	<ul style="list-style-type: none"> <li>• Intel HD Graphics 3000</li> <li>• Intel HD Graphics 100</li> <li>• Intel HD Graphics</li> </ul>		

Category	Description	Computer models equipped with an AMD processor	Computer models equipped with an Intel processor
	<p><b>Switchable discrete graphics:</b></p> <ul style="list-style-type: none"> <li>ATI Mobility Radeon HD 6470M with 1024-MB of discrete video memory (128-MB × 16 DDR3 @ 900 MHz × 4 PCs), 64-bit S3 package, muxless switchable</li> <li>ATi Mobility Radeon HD 6470M with 512-MB of discrete video memory (64-MB × 16 DDR3 @ 900 MHz × 4 PCs), 64-bit S3 package, muxless switchable</li> </ul>	√	√
	Supports DX11	√	
	Support HD decode, DX11, and HDMI		√
<b>Panel</b>	<p>17.3-in, high-definition+ (HD+), light-emitting diode (LED), SVA BrightView (1600×900) display; typical brightness: 200 nits</p> <p>All display assemblies include 2 wireless local area network (WLAN) antenna cables</p> <p>Supports 16:9 ultra wide aspect ratio</p>	√	√
<b>Memory</b>	2 customer-accessible/upgradable memory module slots	√	√
	Supports dual-channel memory	√	√
	Supports up to 8192 GB of system RAM	√	√
	DDR3/1333-MHz	√	√
	Supports the following configurations:	√	√
	<ul style="list-style-type: none"> <li>8192-MB total system memory (4096×2; not supported on a 32-bit operating system)</li> <li>6144-MB total system memory (4096×1 + 2048×1; not supported on a 32-bit operating system)</li> <li>4096-MB total system memory (4096×1 or 2048×2)</li> <li>3072-MB total system memory (2048×1 + 1024×1)</li> <li>2048-MB total system memory (2048×1 or 1024×2)</li> <li>1024-MB total system memory (1024×1; not supported on a 64-bit operating system)</li> </ul>		

Category	Description	Computer models equipped with an AMD processor	Computer models equipped with an Intel processor
<b>Hard drives</b>	Supports <b>6.35-cm</b> (2.5-in) hard drives in <b>12.7-mm</b> (.50-in), <b>9.5-mm</b> (.37-in), and <b>7.0-mm</b> (.28-in) thicknesses	√	√
	Customer-accessible	√	√
	Serial ATA	√	√
	Supports the following configurations:	√	√
	<ul style="list-style-type: none"> <li>• 750 GB, 5400 rpm (9.5 mm)</li> <li>• 640 GB, 5400 rpm (9.5 mm)</li> <li>• 500 GB, 7200 and 5400 rpm (9.5 mm)</li> <li>• 320 GB, 7200 (7.0 mm) and 5400 rpm (9.5 mm)</li> <li>• 250 GB, 7200 and 5400 rpm (7.0 mm)</li> </ul>		
<b>Optical drive</b>	Fixed	√	√
	Serial ATA	√	√
	12.7-mm tray load	√	√
	Blu-ray ROM with LightScribe DVD ±R/RW Super Multi Double-Layer Drive	√	√
	DVD±RW and CD-RW Super Multi Double-Layer Combo Drive with LightScribe	√	√
<b>Audio and video</b>	Single digital microphone	√	√
	HD audio	√	√
	HP-branded Altec/Lansing speakers	√	√
	Supports Microsoft Premium requirements	√	√
	HP VGA webcam (fixed, no tilt with activity LED, 640×480 by 24 frames per second)	√	√
<b>Ethernet</b>	Integrated 10/100 network interface card (NIC)	√	√
<b>Wireless</b>	Integrated wireless local area network (WLAN) options by way of wireless module	√	√
	Two WLAN antennas built into display assembly	√	√

Category	Description	Computer models equipped with an AMD processor	Computer models equipped with an Intel processor
	Support for the following WLAN formats: <ul style="list-style-type: none"> <li>Broadcom 4313 802.11b/g/n 1x1 WiFi and 2070 Bluetooth 2.1+EDR Combo adapter (BT3.0+HS ready)</li> <li>Ralink 5390GN 802.11b/g/n 1x1 WiFi Adapter</li> <li>Ralink RT3090BC4 802.11b/g/n 1x1 WiFi and Bluetooth 2.1+EDR Combo Adapter (BT3.0+HS ready)</li> </ul>	√	√
	Support for the following WLAN formats: <ul style="list-style-type: none"> <li>Atheros 9285G 802.11b/g/n 1x1 WiFi Adapter</li> <li>Atheros AR8002WB-1NGB 802.11b/g/n 1x1 WiFi and Bluetooth 2.1+EDR Combo Adapter (BT3.0+HS ready)</li> <li>Broadcom 4313 802.11b/g/n 1x1 WiFi Adapter</li> <li>Realtek RTL8191SE 802.11b/g/n 1x1 WiFi Adapter</li> <li>Realtek 8188BC8 802.11a/b/g/n 2x2 WiFi and Bluetooth 3.0+HS Combo Adapter</li> </ul>	√	
	Support for the following WLAN formats: <ul style="list-style-type: none"> <li>Intel Centrino Wireless-N 1000 WLAN module</li> <li>Intel Centrino Advanced-N 6230</li> <li>Intel Centrino Wireless-N 1000</li> </ul>		√
<b>External media card</b>	HP Multi-Format Digital Media Reader supports the following digital card formats: <ul style="list-style-type: none"> <li>Secure Digital (SD) Memory Card</li> <li>Secure Digital High Capacity (SDHC) Memory Card</li> <li>Secure Digital Extended Capacity (SDXC) Memory Card</li> <li>MultiMediaCard (MMC)</li> </ul>	√	√

Category	Description	Computer models equipped with an AMD processor	Computer models equipped with an Intel processor
<b>Ports</b>	<ul style="list-style-type: none"> <li>3-pin AC power</li> </ul>	√	√
	<ul style="list-style-type: none"> <li>Audio-in (mono microphone)</li> </ul>		
	<ul style="list-style-type: none"> <li>Audio-out (stereo headphone)</li> </ul>		
	<ul style="list-style-type: none"> <li>HDMI version 1.4 supporting up to 1080p, 1920 × 1200 @ 60Hz and 1920 × 1200 @ 60Hz in DVI mode</li> </ul>		
	<ul style="list-style-type: none"> <li>RJ-45 (Ethernet, includes link and activity lights)</li> </ul>		
	<ul style="list-style-type: none"> <li>USB 2.0 (3 ports)</li> </ul>		
	<ul style="list-style-type: none"> <li>VGA (Dsub 15 pin) supporting 2048×1056 external resolution @ 75 Hz, 1920 × 1200 external resolution @ 60Hz, hot plug and unplug and auto-detection for correct output to wide-aspect vs. standard aspect video</li> </ul>		
<b>Keyboard/ pointing devices</b>	Full-size, textured, pocket, keyboard with full numeric keypad	√	√
	TouchPad with multi-touch gestures, 2-finger scrolling, and pinch-zoom enabled	√	√
	Taps enabled by default	√	√
<b>Power requirements</b>	90W slim travel AC adapter with localized cable plug support (3-wire plug with ground pin, supports 3-pin DC connector)	√	√
	65 W slim travel AC adapter with localized cable plug support (3-wire plug with ground pin, supports 3-pin DC connector)		
	<b>Support for the following batteries:</b> <ul style="list-style-type: none"> <li>6-cell, 55-Whr, 2.55-Ah Li-ion battery</li> <li>6-cell, 47-Whr, 2.20-Ah Li-ion battery</li> </ul>	√	√
<b>Security</b>	Security cable slot	√	√
	Supports Intel AT-p Ready		√
<b>Operating system</b>	<b>Preinstalled:</b>	√	
	<ul style="list-style-type: none"> <li>Windows 7 Home Premium 64-bit</li> <li>Windows 7 Professional 64-bit</li> </ul>		

Category	Description	Computer models equipped with an AMD processor	Computer models equipped with an Intel processor
	<p><b>Preinstalled:</b></p> <ul style="list-style-type: none"> <li>• Windows 7 Home Basic (64-and 32-bit)</li> <li>• Windows 7 Home Premium (64-and 32-bit)</li> <li>• Windows 7 Professional (64-and 32-bit)</li> <li>• Windows 7 Starter 32-bit</li> <li>• FreeDOS</li> </ul>		√
<b>Serviceability</b>	<p><b>End-user replaceable parts:</b></p> <ul style="list-style-type: none"> <li>• AC adapter</li> <li>• Battery</li> <li>• Hard drive</li> <li>• Memory modules (2)</li> <li>• Optical drive</li> <li>• WLAN module</li> </ul>	√	√



---

## **2 External component identification**

# Top Button



Component	Description
Power button	<ul style="list-style-type: none"><li>• When the computer is off, press the button to turn on the computer.</li><li>• When the computer is on, press the button briefly to initiate Sleep.</li><li>• When the computer is in the Sleep state, press the button briefly to exit Sleep.</li><li>• When the computer is in Hibernation, press the button briefly to exit Hibernation.</li></ul> <p>If the computer has stopped responding and Windows shutdown procedures are ineffective, press and hold the power button for at least 5 seconds to turn off the computer.</p> <p>To learn more about your power settings, select <b>Start &gt; Control Panel &gt; System and Security &gt; Power Options</b>, or refer to the <i>HP Notebook Reference Guide</i>.</p>

# Keys

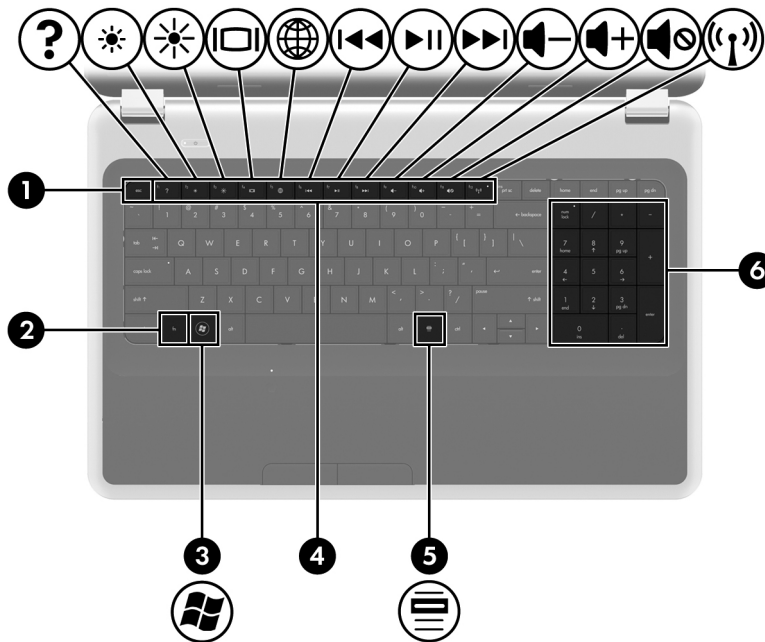

Item	Component	Description
(1)	esc key	Displays system information when pressed in combination with the <b>fn</b> key.
(2)	fn key	Displays system information when pressed in combination with the <b>esc</b> key.
(3)	Windows logo key	Displays the Windows Start menu.
(4)	Action keys	Execute frequently used system functions.
(5)	Windows applications key	Displays a shortcut menu for items beneath the pointer.
(6)	Integrated numeric keypad	Can be used like an external numeric keypad.

# Lights

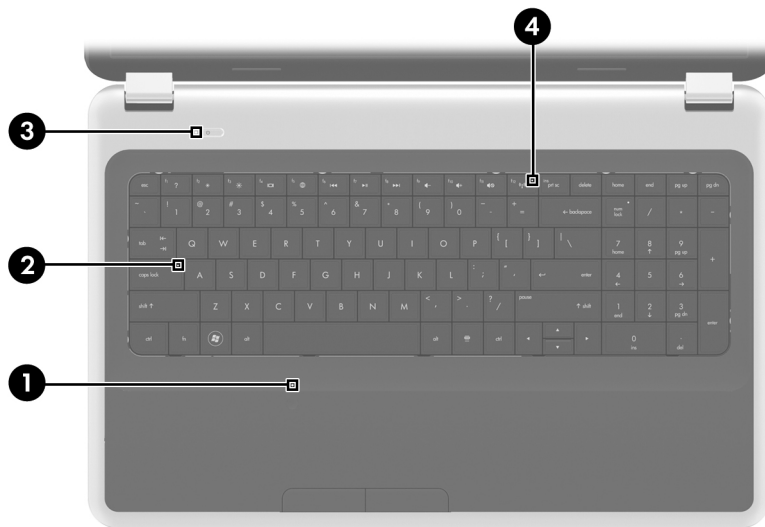

Item	Component	Description
(1)	TouchPad light	<ul style="list-style-type: none"><li>• Amber: the TouchPad is off.</li><li>• Off: the TouchPad is on.</li></ul>
(2)	Caps lock light	<ul style="list-style-type: none"><li>• White: Caps lock is on.</li><li>• Off: Caps lock is off.</li></ul>
(3)	Power light	<ul style="list-style-type: none"><li>• White: the computer is on.</li><li>• Blinking white: the computer is in the Sleep state.</li><li>• Off: the computer is off or in Hibernation.</li></ul>
(4)	Wireless light	<ul style="list-style-type: none"><li>• White: An integrated wireless device, such as a WLAN device and/or a Bluetooth device, is on.</li><li>• Amber: All wireless devices are off.</li></ul>

## TouchPad

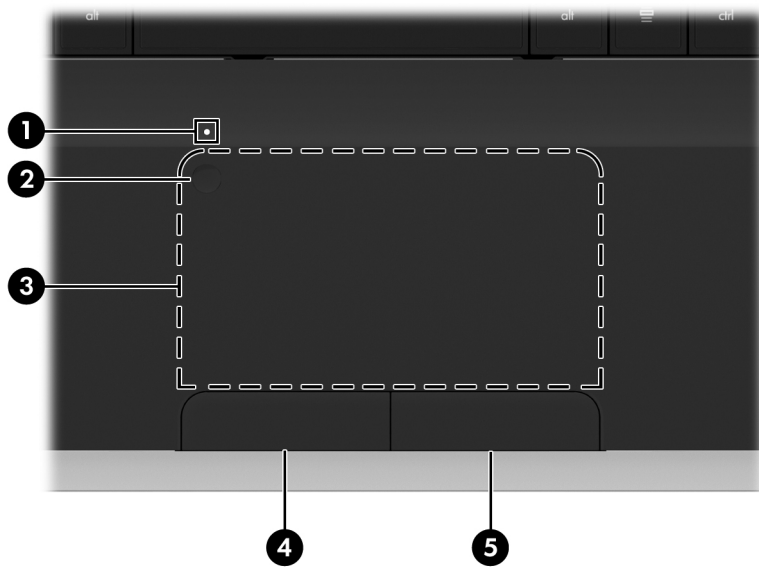

Item	Component	Description
(1)	TouchPad light	<ul style="list-style-type: none"><li>• Amber: the TouchPad is off.</li><li>• On: the TouchPad is on.</li></ul>
(2)	TouchPad on/off button	Turns the TouchPad on and off. Quickly double-tap the TouchPad on/off button to turn the TouchPad on and off.
(3)	TouchPad zone	Moves the pointer and selects or activates items on the screen.
(4)	Left TouchPad button	Functions like the left button on an external mouse.
(5)	Right TouchPad button	Functions like the right button on an external mouse.

# Display

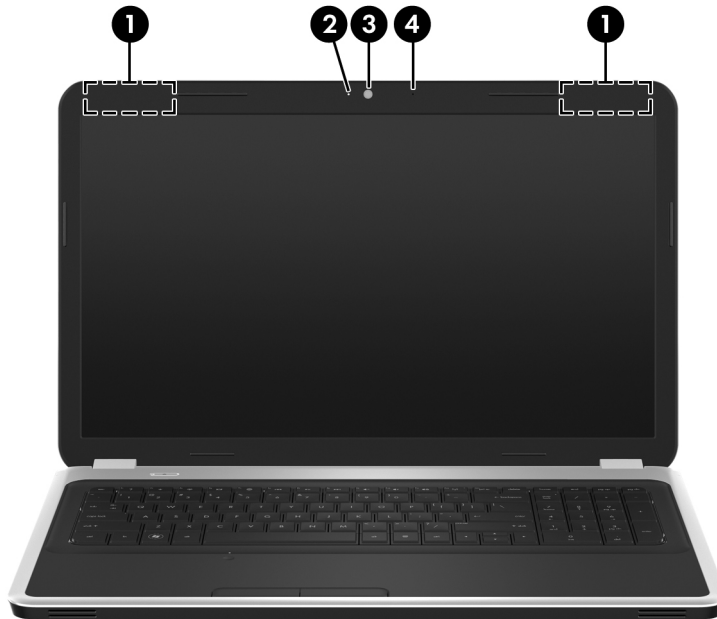

Item	Component	Description
(1)	WLAN antennas (2)*	Send and receive wireless signals to communicate with WLANs.
(2)	Webcam light	On: The webcam is in use.
(3)	Webcam	Records video and captures still photographs. To use the webcam, select <b>Start &gt; All Programs &gt; CyberLink YouCam</b> .
(4)	Internal microphone	Records sound.

\*The antennas are not visible from the outside of the computer. For optimal transmission, keep the areas immediately around the antennas free from obstructions. To see wireless regulatory notices, refer to the section of the *Regulatory, Safety, and Environmental Notices* that applies to your country or region. These notices are located in Help and Support.

# Front



Component	Description
Speakers (2)	Produce sound.

# Left side

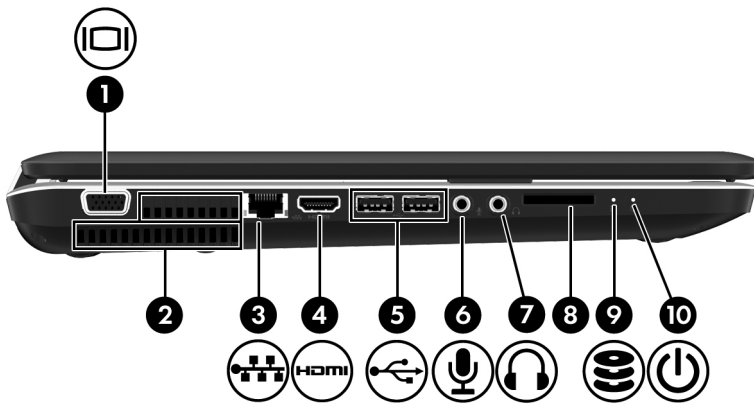

Item	Component	Description
(1)	External monitor port	Connects an external VGA monitor or projector.
(2)	Vents (2)	Enable airflow to cool internal components.  <b>NOTE:</b> The computer fan starts up automatically to cool internal components and prevent overheating. It is normal for the internal fan to cycle on and off during routine operation.
(3)	RJ-45 (network) jack	Connects a network cable.
(4)	HDMI port	Connects an optional video or audio device, such as a high-definition television, or any compatible digital or audio component.
(5)	USB ports (2)	Connect optional USB devices.
(6)	Audio-in (microphone) jack	Connects an optional computer headset microphone, stereo array microphone, or monaural microphone.
(7)	Audio-out (headphone) jacks (2)	Produce sound when connected to optional powered stereo speakers, headphones, ear buds, a headset, or television audio.  <b>WARNING!</b> To reduce the risk of personal injury, adjust the volume before putting on headphones, earbuds, or a headset. For additional safety information, refer to the <i>Regulatory, Safety, and Environmental Notices</i> .

Item	Component	Description
(8)	Digital Media Slot	Supports the following digital card formats: <ul style="list-style-type: none"> <li>Secure Digital (SD) Memory Card</li> <li>Secure Digital High Capacity (SDHC) Memory Card</li> <li>Secure Digital Extended Capacity (SDXC) Memory Card</li> <li>MultiMediaCard</li> </ul>
(9)	Drive light	Blinking white: the hard drive is being accessed.
(10)	Power light	<ul style="list-style-type: none"> <li>White: The computer is on.</li> <li>Blinking white: The computer is in the Sleep state.</li> <li>Off: The computer is off or in Hibernation.</li> </ul>

## Right side

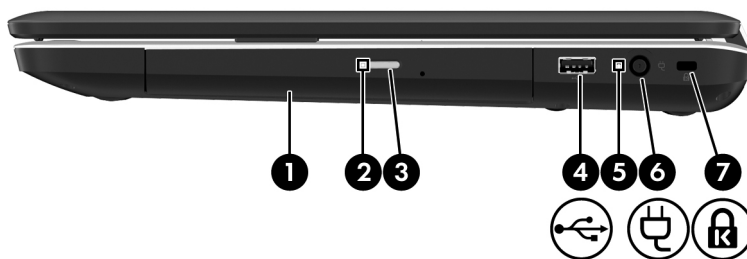

Item	Component	Description
(1)	Optical drive	Reads and writes to an optical disc.
(2)	Optical drive light	Blinking: The optical drive is being accessed.
(3)	Optical drive eject button	Opens the optical drive.
(4)	USB port	Connects an optional USB device.
(5)	AC adapter light	<ul style="list-style-type: none"> <li>White: The computer is connected to external power and the battery is fully charged.</li> <li>Blinking white: The battery has reached a low battery level.</li> <li>Amber: A battery is charging.</li> </ul>
(6)	Power connector	Connects an AC adapter.
(7)	Security cable slot	Connects an optional security cable.

**NOTE:** The security cable is designed to act as a deterrent, but it may not prevent the computer from being mishandled or stolen.



# Bottom

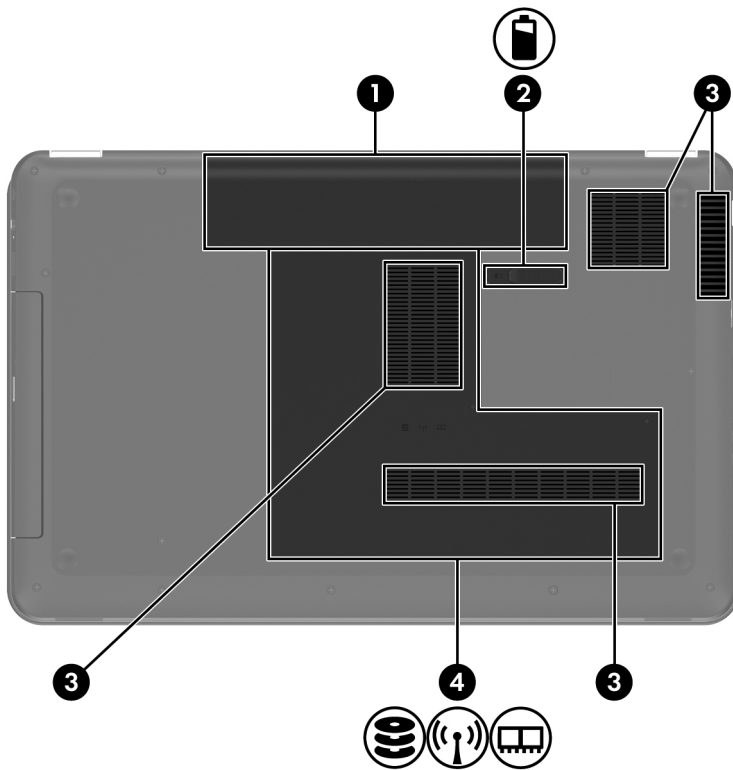

Item	Component	Description
(1)	Battery bay	Holds the battery.
(2)	Battery release latch	Releases the battery from the battery bay.
(3)	Vents (4)	Enable airflow to cool internal components.  <b>NOTE:</b> The computer fan starts up automatically to cool internal components and prevent overheating. It is normal for the internal fan to cycle on and off during routine operation.
(4)	Hard drive bay	Holds the hard drive, the memory module slots, and the WLAN module.  <b>CAUTION:</b> To prevent an unresponsive system, replace the wireless module only with a wireless module authorized for use in the computer by the governmental agency that regulates wireless devices in your country or region. If you replace the module and then receive a warning message, remove the module to restore computer functionality, and then contact technical support through Help and Support.

# 3 Illustrated parts catalog

## Service tag

When ordering parts or requesting information, provide the computer serial number and model description provided on the service tag.

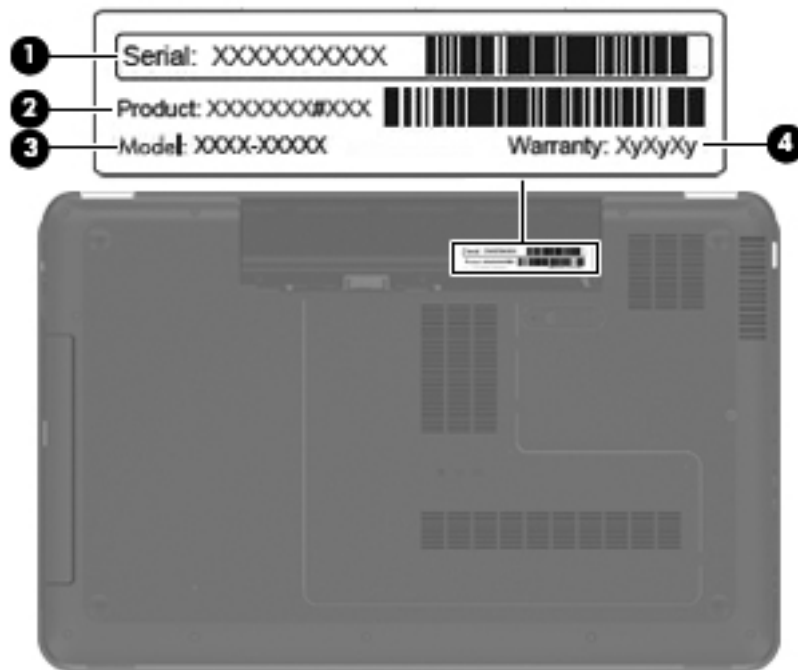

Item	Description	Function
(1)	Serial number (s/n)	This is an alphanumeric identifier that is unique to each product.
(2)	Part number/Product number (p/n)	This number provides specific information about the product's hardware components. The part number helps a service technician to determine what components and parts are needed.
(3)	Model description:	This is the alphanumeric identifier needed to locate documents, drivers, and support for the computer.
(4)	Warranty period	This number describes the duration of the warranty period for the computer.

# Computer major components

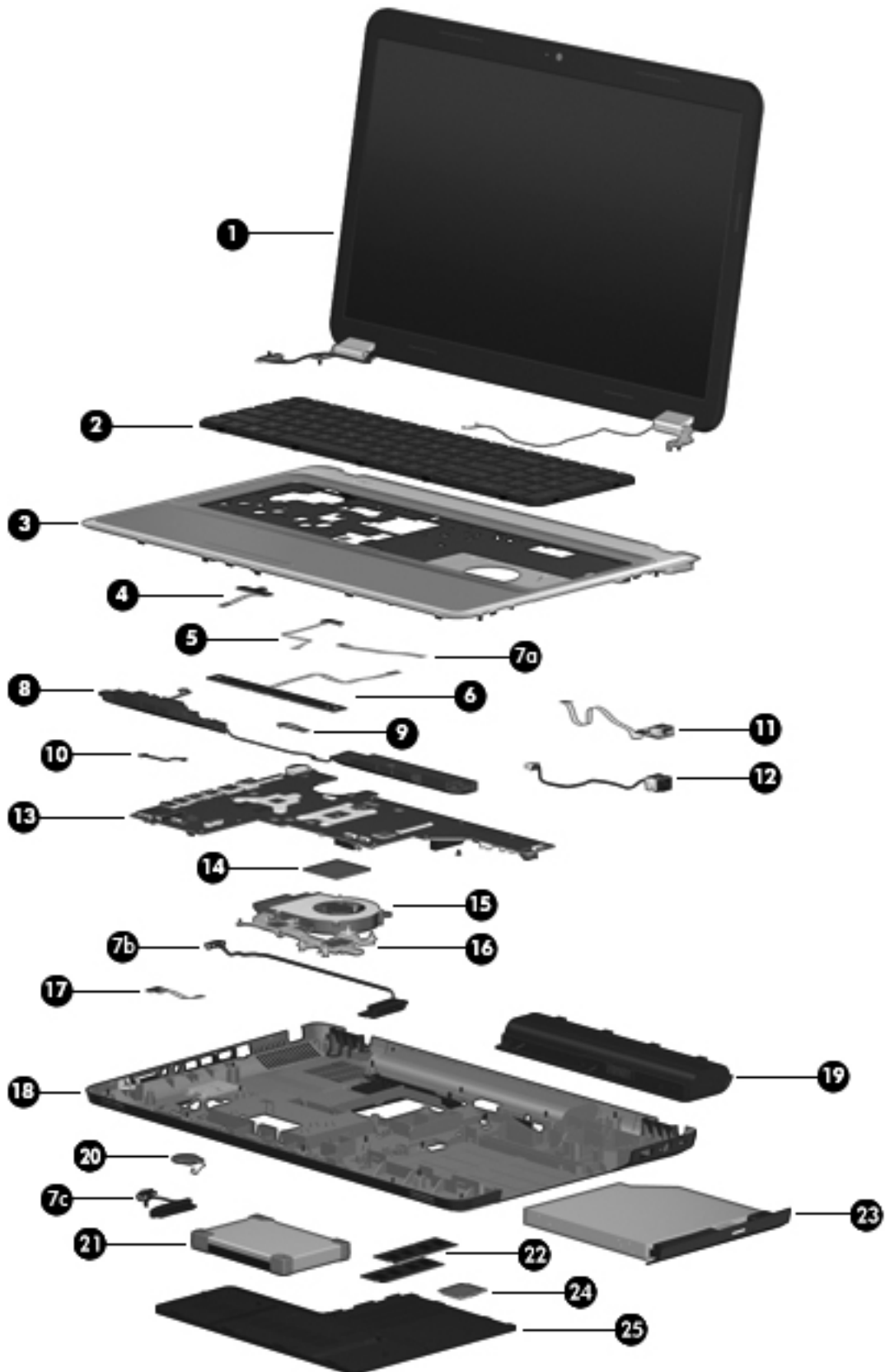

<b>Item</b>	<b>Component</b>	<b>Spare part number</b>
<b>(1)</b>	<b>17.3-in, high definition (HD), light-emitting diode (LED), BrightView display assembly</b> (includes webcam, two microphones, and wireless antenna transceivers and cables)	
	In butter gold finish	640223-001
	In charcoal gray finish	640226-001
	In luminous rose finish	640225-001
	In ocean drive finish	640224-001
	In Pacific blue finish	640221-001
	In pearl pink finish	640228-001
	In pewter finish	640227-001
	In Sonoma red finish	640220-001
	In sweet purple finish	640222-001
	<b>NOTE:</b> For more display assembly spare part information, see <a href="#">Display assembly subcomponents on page 28</a> .	
<b>(2)</b>	<b>Keyboard</b> (includes keyboard cable):	
	Keyboard in black finish	
	For use in Belgium	640208-A41
	For use in Bulgaria (for use only with computer models equipped with an AMD processor)	640208-261
	For use in Canada	640208-121
	For use in the Czech Republic	640208-221
	For use in Denmark, Finland, and Norway	640208-DH1
	For use in France	640208-051
	For use in Germany	640208-041
	For use in Greece	640208-DJ1
	For use in Hungary	640208-211
	For use in Israel	640208-BB1
	For use in Italy	640208-061
	For use in the Netherlands	640208-B31
	For use in Portugal	640208-131
	For use in Russia	640208-251
	For use in Saudi Arabia	640208-171
	For use in Slovenia	640208-BA1
	For use in Spain	640208-071
	For use in Switzerland	640208-BG1

<b>Item</b>	<b>Component</b>	<b>Spare part number</b>
	For use in Turkey	640208-141
	For use in the United Kingdom	640208-031
	For use in the United States	640208-001
	Keyboard in silver finish	
	For use in Belgium	647630-A41
	For use in Bulgaria (for use only with computer models equipped with an AMD processor)	647630-261
	For use in Canada	647630-121
	For use in the Czech Republic	647630-221
	For use in Denmark, Finland, and Norway	647630-DH1
	For use in France	647630-051
	For use in Germany	647630-041
	For use in Greece	647630-DJ1
	For use in Hungary	647630-211
	For use in Israel	647630-BB1
	For use in Italy	647630-061
	For use in the Netherlands	647630-B31
	For use in Portugal	647630-131
	For use in Russia	647630-251
	For use in Saudi Arabia	647630-171
	For use in Slovakia (for use only with computer models equipped with an Intel processor)	647630-FL1
	For use in Slovenia	647630-BA1
	For use in Spain	647630-071
	For use in Switzerland	647630-BG1
	For use in Turkey	647630-141
	For use in the United Kingdom	647630-031
	For use in the United States	647630-001
<b>(3)</b>	<b>Top cover</b> (includes TouchPad and TouchPad cable):	
	In butter gold finish	641401-001
	In charcoal gray finish	641404-001
	In luminous rose finish	641403-001
	In ocean drive finish	641402-001

<b>Item</b>	<b>Component</b>	<b>Spare part number</b>
	In Pacific blue finish	641399-001
	In pearl pink finish	641406-001
	In pewter finish	641405-001
	In Sonoma red finish	640193-001
	In sweet purple finish	641400-001
<b>(4)</b>	<b>Power button board</b> (includes cable)	640212-001
<b>(5)</b>	<b>TouchPad LED board</b> (includes cable)	640213-001
<b>(6)</b>	<b>TouchPad button board</b> (includes cable)	640214-001
	<b>Cable Kit</b> , includes:	640206-001
<b>(7a)</b>	TouchPad cable	
<b>(7b)</b>	Optical drive cable	
<b>(7c)</b>	Hard drive connector cable	
	<b>NOTE:</b> See <a href="#">Cable Kit on page 27</a> for more Cable Kit spare part information.	
<b>(8)</b>	<b>Speaker Kit</b> (includes left and right speakers and cable)	641396-001
<b>(9)</b>	<b>Bluetooth module</b> (for use only with computer models equipped with an Intel processor)	537921-001
	<b>NOTE:</b> The Bluetooth module spare part kit does not include the Bluetooth module cable. The Bluetooth module cable is available using spare part number 602538-001.	
<b>(10)</b>	<b>Bluetooth module cable</b> (for use only with computer models equipped with an Intel processor)	602538-001
<b>(11)</b>	<b>USB board</b> (includes cable)	640211-001
<b>(12)</b>	<b>Power connector cable</b>	641394-001
<b>(13)</b>	<b>System board</b> (includes replacement thermal material):	
	For use only with computer models equipped with an AMD processor:	
	Equipped with an AMD Fusion E-450 1.65-GHz processor (dual core, 18 W) and a graphics subsystem with UMA video memory	660773-001
	For use only with computer models equipped with the AMD A60M chipset and a graphics subsystem with 1024-MB of discrete video memory	649950-001
	For use only with computer models equipped with the AMD A60M chipset and a graphics subsystem with 512-MB of discrete video memory	649949-001
	For use only with computer models equipped with the AMD A60M chipset and a graphics subsystem with UMA video memory	649948-001
	For use only with computer models equipped with the AMD RS880MD chipset and a graphics subsystem with 1024-MB of discrete video memory	647627-001
	For use only with computer models equipped with the AMD RS880MD chipset and a graphics subsystem with 512-MB of discrete video memory	647626-001

<b>Item</b>	<b>Component</b>	<b>Spare part number</b>
	For use only with computer models equipped with an AMD Athlon, Phenom, Turion, or V-series processor and a graphics subsystem with 1024-MB of discrete video memory	638855-001
	For use only with computer models equipped with an AMD Athlon, Phenom, Turion, or V-series processor and a graphics subsystem with 512-MB of discrete video memory	638854-001
	For use only with computer models equipped with an AMD Athlon, Phenom, Turion, or V-series processor and a graphics subsystem with UMA video memory	638856-001
	For use only with computer models equipped with an Intel processor:	
	For use only with computer models equipped with the Intel HM65 chipset and a graphics subsystem with 1024-MB of discrete video memory and supports bus alive/ chip off (BACO)	650199-001
	For use only with computer models equipped with the Intel HM65 chipset and a graphics subsystem with 512-MB of discrete video memory and supports bus alive/ chip off (BACO)	650198-001
	For use only with computer models equipped with the HM65 chipset and a graphics subsystem with 1024-MB of discrete video memory	636375-001
	For use only with computer models equipped with the HM65 chipset and a graphics subsystem with 512-MB of discrete video memory	636374-001
	For use only with computer models equipped with the HM65 chipset and a graphics subsystem with UMA video memory	636373-001
	For use only with computer models equipped with the HM55 chipset and a graphics subsystem with 1024-MB of discrete video memory	636372-001
	For use only with computer models equipped with the HM55 chipset and a graphics subsystem with 512-MB of discrete video memory	636371-001
	For use only with computer models equipped with the HM55 chipset and a graphics subsystem with UMA video memory	636370-001
	Equipped with an Intel Core i3-370M 2.40-GHz processor (3.0-MB L3 cache, dual core, 35 W), the HM55 chipset, and a graphics subsystem with 1024-MB of discrete video memory	654117-001
	Equipped with an Intel Core i3-370M 2.40-GHz processor (3.0-MB L3 cache, dual core, 35 W), the HM55 chipset, and a graphics subsystem with UMA video memory	654118-001
	<b>Thermal Material Kit</b> (includes replacement thermal paste and pads)	634433-001
<b>(14)</b>	<b>Processor</b> (includes replacement thermal material)	
	AMD A8-3500M 2.40-GHz processor (1.5-GHz FSB, 4.0-MB L2 cache, quad core, 35 W)	653350-001
	AMD A6-3400M 2.30-GHz processor (1.4-GHz FSB, 4.0-MB L2 cache, quad core, 35 W)	653349-001
	AMD A4-3300M 2.50-GHz processor (1.9-GHz FSB, 4.0-MB L2 cache, dual core, 35 W)	653348-001
	AMD Athlon II P360 2.30-GHz processor (1.0-MB L2 cache, 1066-MHz, 3.2GT/sec, dual core, 25 W)	636635-001

<b>Item</b>	<b>Component</b>	<b>Spare part number</b>
	AMD Athlon II P340 2.20-GHz processor (1.0-MB L2 cache, 1066-MHz, 3.2GT/sec, dual core, 25 W)	616343-001
	AMD Phenom II N970 2.20-GHz processor (2.0-MB L2 cache, 1333-MHz, 3.6GT/sec, quad core, 35 W)	635496-001
	AMD Phenom II N870 2.30-GHz processor (1.5-MB L2 cache, 1333-MHz, 3.6GT/sec, triple core, 35 W)	635495-001
	AMD Phenom II N850 2.20-GHz processor (1.5-MB L2 cache, 1333-MHz, 3.6GT/sec, triple core, 35 W)	616345-001
	AMD Phenom II N660 3.00-GHz processor (2.0-MB L2 cache, 1333-MHz, 3.6GT/sec, dual core, 35 W)	635494-001
	AMD Phenom II P960 1.80-GHz processor (2.0-MB L2 cache, 1066-MHz, 3.6GT/sec, quad core, 25 W)	634689-001
	AMD Phenom II P860 2.00-GHz processor (1.5-MB L2 cache, 1333-MHz, 3.6GT/sec, triple core, 25 W)	634688-001
	AMD Phenom II P650 2.60-GHz processor (2.0-MB L2 cache, 1066-MHz, 3.6GT/sec, triple core, 25 W)	634687-001
	AMD Turion II P560 2.50-GHz processor (2.0-MB L2 cache, 1066-MHz, 3.6GT/sec, dual core, 25 W)	634691-001
	AMD V160 2.40-GHz processor (512-KB L2 cache, 1066-MHz 3.2GT/sec, single core, 25 W)	616333-001
	AMD V140 2.30-GHz processor (512-KB L2 cache, 1066-MHz 3.2GT/sec, single core, 25 W)	636634-001
	Intel Core i7-2620M 2.70-GHz (SC turbo up to 3.40-GHz) processor (4.0-MB L3 cache, dual core, 35 W)	631252-001
	Intel Core i5-2540M 2.60-GHz (SC turbo up to 3.30-GHz) processor (3.0-MB L3 cache, dual core, 35 W)	631255-001
	Intel Core i5-2520M 2.50-GHz (SC turbo up to 3.20-GHz) processor (3.0-MB L3 cache, dual core, 35 W)	631253-001
	Intel Core i5-2430M 2.40-GHz (SC turbo up to 3.00-GHz) processor (3.0-MB L3 cache, dual core, 35 W)	653341-001
	Intel Core i5-2410M 2.30-GHz (SC turbo up to 2.90-GHz) processor (3.0-MB L3 cache, dual core, 35 W)	638039-001
	Intel Core i5-480M 2.66-GHz (SC turbo up to 2.93-GHz) processor (3.0-MB L3 cache, dual core, 35 W)	634693-001
	Intel Core i3-2350M 2.30-GHz processor (3.0-MB L3 cache, dual core, 35 W)	653340-001
	Intel Core i3-2330M 2.20-GHz processor (3.0-MB L3 cache, dual core, 35 W)	653339-001
	Intel Core i3-2310M 2.10-GHz processor (3.0-MB L3 cache, dual core, 35 W)	638037-001
	Intel Core i3-390M 2.66-GHz processor (3.0-MB L3 cache, dual core, 35 W)	634692-001
	Intel Core i3-380M 2.53-GHz processor (3.0-MB L3 cache, dual core, 35 W)	625823-001
	Intel Pentium B950 TJ85 2.10-GHz processor (2.0-MB L3 cache, dual core 35 W)	653338-001



<b>Item</b>	<b>Component</b>	<b>Spare part number</b>
	Intel Pentium B940 TJ85 2.00-GHz processor (2.0-MB L3 cache, dual core 35 W)	653337-001
	Intel Pentium P6200 2.13-GHz processor (3.0-MB L3 cache, dual core, 35 W)	625831-001
	Intel Pentium P6300 2.26-GHz processor (3.0-MB L3 cache, dual core, 35 W)	635500-001
<b>(15)</b>	<b>Fan</b> (includes replacement thermal material)	639460-001
<b>(16)</b>	<b>Heat sink</b> (includes replacement thermal material)	
	For use only with computer models equipped with an AMD processor:	
	For use only with computer models equipped with the AMD A60M chipset and a graphics subsystem with discrete video memory	649953-001
	For use only with computer models equipped with the AMD A60M chipset and a graphics subsystem with UMA video memory	649954-001
	For use only with computer models equipped with the AMD RS880MD chipset and a graphics subsystem with discrete video memory	649952-001
	For use only with computer models equipped with an AMD Athlon, Phenom, Turion, or V-series processor and a graphics subsystem with discrete video memory	639462-001
	For use only with computer models equipped with an AMD Athlon, Phenom, Turion, or V-series processor and a graphics subsystem with UMA video memory	639463-001
	For use only with computer models equipped with an Intel processor:	
	For use only with computer models equipped with the Intel HM65 or HM55 chipset and a graphics subsystem with discrete video memory and supports bus alive/chip off (BACO)	654119-001
	For use only with computer models equipped with the Intel HM65 or HM55 chipset and a graphics subsystem with UMA video memory and supports bus alive/chip off (BACO)	654120-001
	For use only with computer models equipped with the HM65 chipset and a graphics subsystem with discrete video memory	641141-001
	For use only with computer models equipped with the HM65 chipset and a graphics subsystem with UMA video memory	641140-001
	For use only with computer models equipped with the HM55 chipset and a graphics subsystem with discrete video memory	637190-001
	For use only with computer models equipped with the HM55 chipset and a graphics subsystem with UMA video memory	637189-001
<b>(17)</b>	<b>LED board</b> (includes cable)	640215-001
<b>(18)</b>	<b>Base enclosure</b> (includes battery release latch, heat sink, replacement thermal material, and 4 rubber feet)	640203-001
	<b>Rubber Feet Kit</b> (not illustrated, includes 4 rubber feet)	639455-001
<b>(19)</b>	<b>Battery:</b>	
	6-cell, 55-Whr, 2.55-Ah Li-ion battery	593554-001
	6-cell, 47-Whr, 2.20-Ah Li-ion battery	593553-001

<b>Item</b>	<b>Component</b>	<b>Spare part number</b>
<b>(20)</b>	<b>RTC battery</b> (includes cable and double-sided tape)	637193-001
<b>(21)</b>	<b>Hard drive</b> (2.5-in, 7.0-mm, SATA, does not include hard drive connector cable, isolators, or shield):	
	For use with all computer models:	
	750-GB, 5400-rpm	644351-001
	640-GB, 5400-rpm	637312-001
	500-GB, 7200-rpm	644685-001
	320-GB, 7200-rpm	645089-001
	320-GB, 5400-rpm	645086-001
	250-GB, 7200-rpm	645091-001
	<b>Hard Drive Hardware Kit</b> (not illustrated, includes front and rear isolators and shield)	639444-001
<b>(22)</b>	<b>Memory modules</b> (2, DDR3, 10600, 1333-MHz):	
	4 GB	621569-001
	2 GB	621565-001
	1 GB	639736-001
<b>(23)</b>	<b>Optical drive</b> (includes bezel and bracket):	
	Blu-ray ROM with LightScribe DVD±R/RW Super Multi Double-Layer Drive	640210-001 and 659878-001
	DVD±RW and CD-RW Super Multi Double-Layer Combo Drive with LightScribe	640209-001 and 659877-001
	<b>Optical drive bay space saver</b> (not illustrated)	659617-001
<b>(24)</b>	<b>WLAN module:</b>	
	For use on all computer models:	
	Broadcom 4313 802.11b/g/n 1×1 WiFi and 2070 Bluetooth 2.1+EDR Combo adapter (BT3.0+HS ready)	600370-001
	Ralink 5390GN 802.11b/g/n 1×1 WiFi Adapter	630703-001
	Ralink RT3090BC4 802.11b/g/n 1×1 WiFi and Bluetooth 2.1+EDR Combo Adapter (BT3.0+HS ready)	630705-001
	For use only with computer models equipped with an AMD processor:	
	Atheros 9285G 802.11b/g/n 1×1 WiFi Adapter	605560-005
	Atheros AR8002WB-1NGB 802.11b/g/n 1×1 WiFi and Bluetooth 2.1+EDR Combo Adapter (BT3.0+HS ready)	593127-001
	Broadcom 4313 802.11b/g/n 1×1 WiFi Adapter	593836-001
	Broadcom 4313GN 802.11b/g/n 1×1 WiFi and 20702 Bluetooth 4.0 Combo Adapter	657325-001

Item	Component	Spare part number
	Realtek RTL8191SE 802.11b/g/n 1×1 WiFi Adapter	640926-001
	Realtek 8188BC8 802.11a/b/g/n 2×2 WiFi and Bluetooth 3.0+HS Combo Adapter	602993-001
	For use only with computer models equipped with an Intel processor:	
	Atheros 9285G 802.11b/g/n 1×1 WiFi Adapter	518436-001
	Intel Centrino Advanced-N 6230	631956-001
	Intel Centrino Wireless-N 1000	593530-001
<b>(25)</b>	<b>Service cover</b> (includes 2 captive screws, secured by C-clips) — available in the Plastics Kit, spare part number 640216-001)	

## Cable Kit

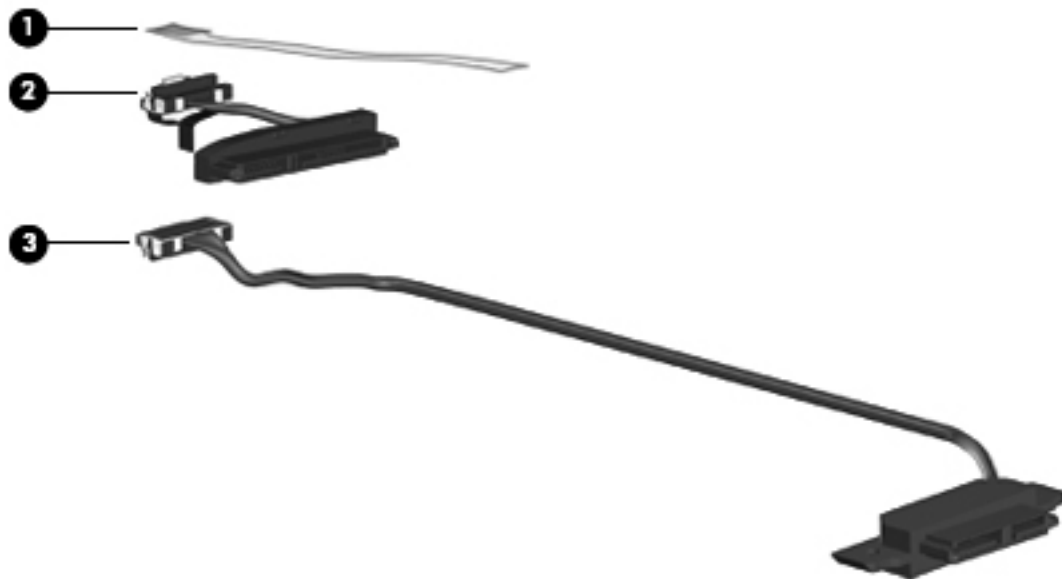

Item	Component	Spare part number
	<b>Cable Kit</b> , includes:	640206-001
<b>(1)</b>	TouchPad cable	
<b>(2)</b>	Hard drive connector cable	
<b>(3)</b>	Optical drive cable	

## Display assembly subcomponents

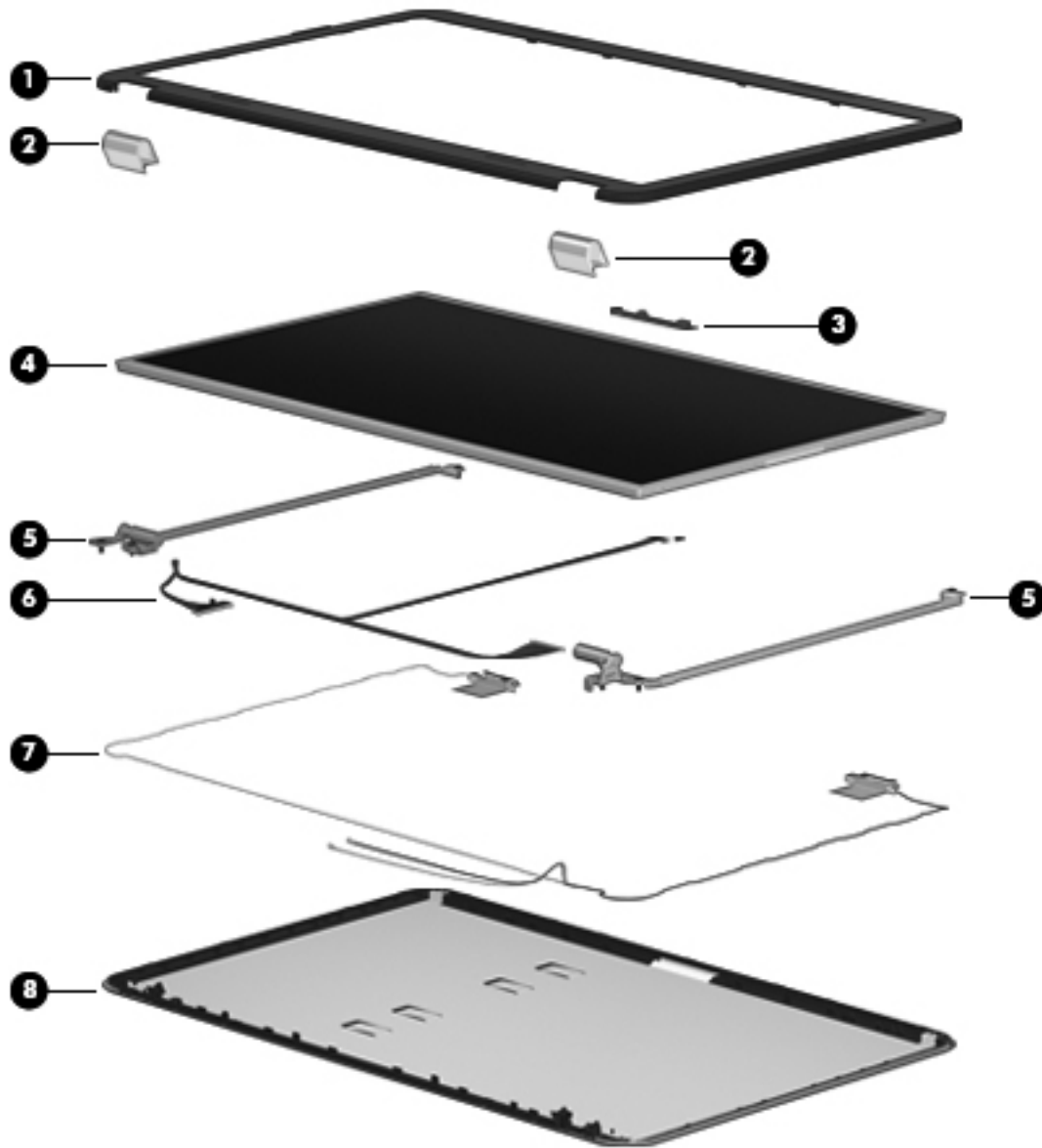

Item	Component	Spare part number
(1)	<b>Display bezel</b>	640204-001
(2)	<b>Display hinge covers (2)</b>	643698-001
(3)	<b>Webcam/microphone module</b>	637197-001
(4)	<b>17.3-in, HD, LED, BrightView display panel</b>	641395-001
(5)	<b>Display Hinge Kit</b> (includes left and right display hinges and brackets)	640207-001
(6)	<b>Display Cable Kit</b> (includes display panel cable and webcam/microphone module cable)	640205-001
(7)	<b>Antenna Kit</b> (includes left and right wireless antenna cables and transceivers)	640192-001

<b>Item</b>	<b>Component</b>	<b>Spare part number</b>
<b>(8)</b>	<b>Display enclosure:</b>	
	In butter gold finish	640197-001
	In charcoal gray finish	640200-001
	In luminous rose finish	640199-001
	In ocean drive finish	640198-001
	In Pacific blue finish	640195-001
	In pearl pink finish	640202-001
	In pewter finish	640201-001
	In Sonoma red finish	640194-001
	In sweet purple finish	640196-001
	<b>Display Screw Kit</b> (not illustrated)	640218-001

## Mass storage devices

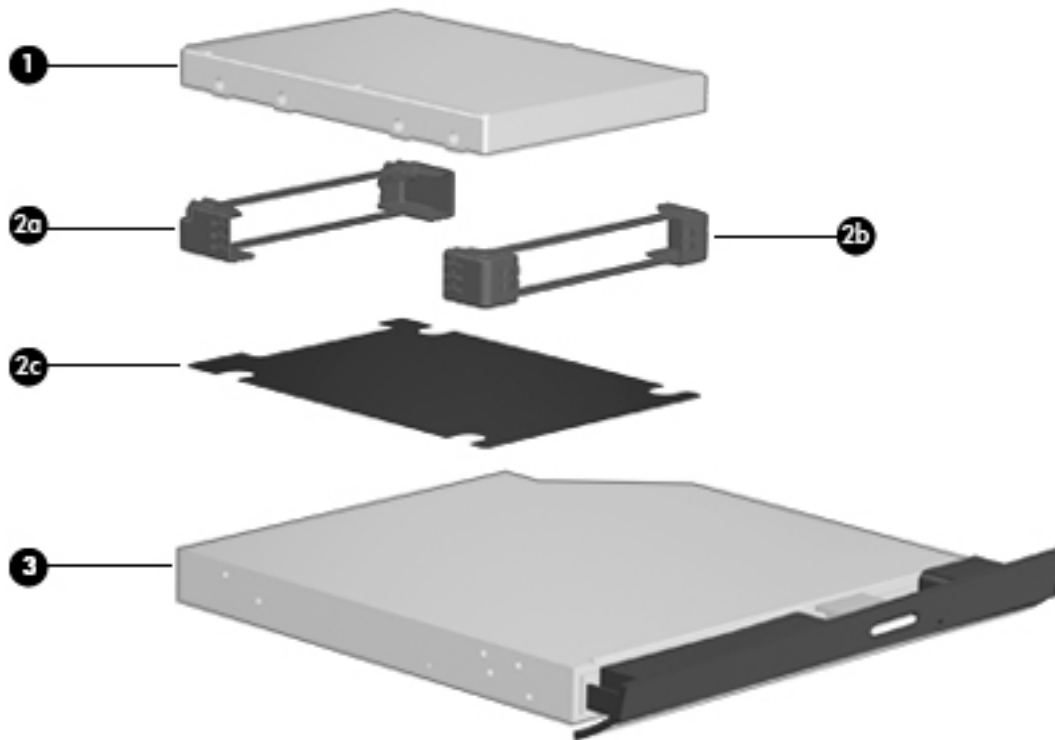

Item	Component	Spare part number
<b>(1)</b>	<b>Hard drive</b> (2.5-in, 7.0-mm, SATA, does not include hard drive connector cable, isolators, or shield):	
	For use with all computer models:	
	750-GB, 5400-rpm	644351-001
	640-GB, 5400-rpm	637312-001
	500-GB, 7200-rpm	644685-001
	320-GB, 7200-rpm	645089-001
	320-GB, 5400-rpm	645086-001
	250-GB, 7200-rpm	645091-001
	<b>Hard Drive Hardware Kit</b> , includes:	639444-001
<b>(2a)</b>	Hard drive front isolator	
<b>(2b)</b>	Hard drive rear isolator	
<b>(2c)</b>	Hard drive shield	
<b>(3)</b>	<b>Optical drive</b> (includes bezel and bracket):	
	Blu-ray ROM with LightScribe DVD±R/RW Super Multi Double-Layer Drive	640210-001 and 659878-001

Item	Component	Spare part number
	DVD±RW and CD-RW Super Multi Double-Layer Combo Drive with LightScribe	640209-001 and 659877-001
	<b>Optical drive bay space saver</b> (not illustrated)	659617-001

## Miscellaneous parts

Component	Spare part number
<b>HP Smart AC adapter</b>	
90-W PFC RC V HP Smart AC adapter	609940-001
65-W RC V HP Smart AC adapter	609939-001
<b>Power cord</b> (3-pin, black, 1.83-m):	
For use in Denmark	490371-081
For use in Europe	490371-021
For use in Israel	490371-BB1
For use in Italy	490371-061
For use in North America	490371-001
For use in South Africa	490371-AR1
For use in Switzerland	490371-111
For use in the United Kingdom and Singapore	490371-031
<b>Screw Kit</b>	640217-001

# Sequential part number listing

Spare part number	Description
490371-001	Power cord for use with all computer models in North America (3-pin, black, 1.83-m)
490371-021	Power cord for use only with computer models equipped with an Intel processor in Europe (3-pin, black, 1.83-m)
490371-031	Power cord for use only with computer models equipped with an Intel processor in the United Kingdom and Singapore (3-pin, black, 1.83-m)
490371-061	Power cord for use with all computer models in Italy (3-pin, black, 1.83-m)
490371-081	Power cord for use with all computer models in Denmark (3-pin, black, 1.83-m)
490371-111	Power cord for use only with computer models equipped with an Intel processor in Switzerland (3-pin, black, 1.83-m)
490371-AR1	Power cord for use only with computer models equipped with an Intel processor in South Africa (3-pin, black, 1.83-m)
490371-BB1	Power cord for use only with computer models equipped with an Intel processor in Israel (3-pin, black, 1.83-m)
518436-001	Atheros 9285G 802.11b/g/n 1×1 WiFi Adapter for use only with computer models equipped with an Intel processor
537921-001	Bluetooth module  <b>NOTE:</b> The Bluetooth module spare part kit does not include a Bluetooth module cable. The Bluetooth module cable is available using spare part number 602538-001.
593127-001	Atheros AR8002WB-1NGB 802.11b/g/n 1×1 WiFi and Bluetooth 2.1+EDR Combo Adapter (BT3.0+HS ready) for use only with computer models equipped with an AMD processor
593530-001	Intel Centrino Wireless-N 1000 WLAN module for use only on computer models equipped with an Intel processor
593553-001	6-cell, 47-W/hr, 2.20-Ah Li-ion battery
593554-001	6-cell, 55-W/hr, 2.55-Ah Li-ion battery
593836-001	Broadcom 4313 802.11b/g/n 1×1 WiFi Adapter for use only on computer models equipped with an AMD processor
600370-001	Broadcom 4313 802.11b/g/n 1×1 WiFi and 2070 Bluetooth 2.1+EDR Combo Adapter (Bluetooth 3.0+HS ready)
602538-001	Bluetooth module cable
602993-001	Realtek 8188BC8 802.11a/b/g/n 2×2 WiFi and Bluetooth 3.0+HS Combo Adapter for use only with computer models equipped with an AMD processor
605560-005	Atheros 9285G 802.11b/g/n 1×1 WiFi Adapter
609939-001	65-W RC V HP Smart AC adapter for use only with computer models equipped with an AMD processor
609940-001	90-W PFC RC V HP Smart AC adapter for use with all computer models



<b>Spare part number</b>	<b>Description</b>
616333-001	AMD V140 2.30-GHz processor (512-KB L2 cache, 1066-MHz 3.2-GT/sec, single core, 25 W; includes replacement thermal material)
616343-001	AMD Athlon II P340 2.20-GHz processor (1.0-MB L2 cache, 1066-MHz, 3.2GT/sec, dual core, 25 W; includes replacement thermal material)
616345-001	AMD Phenom II N850 2.20-GHz processor (1.5-MB L2 cache, 1333-MHz, 3.6GT/sec, triple core, 35 W; includes replacement thermal material)
621565-001	2-GB memory module (DDR3, 10600, 1333-MHz)
621569-001	4-GB memory module (DDR3, 10600, 1333-MHz)
625823-001	Intel i3-380M 2.53-GHz processor (3.0-MB L3 cache, dual core, 35 W; includes replacement thermal material)
625831-001	Intel Pentium P6200 2.13-GHz processor (3.0-MB L3 cache, dual core, 35 W; includes replacement thermal material)
630703-001	Ralink 5390GN 802.11b/g/n 1×1 WiFi Adapter for use only on computer models equipped with an Intel processor
630705-001	Ralink RT3090BC4 802.11b/g/n 1×1 WiFi and Bluetooth 2.1+EDR Combo Adapter (Bluetooth 3.0+HS ready)
631252-001	Intel i7-2620M 2.70-GHz (SC turbo up to 3.40-GHz) processor (4-MB L3 cache, dual core, 35 W; includes replacement thermal material)
631253-001	Intel i5-2520M 2.50-GHz (SC turbo up to 3.20-GHz) processor (3.0-MB L3 cache, dual core, 35 W; includes replacement thermal material)
631255-001	Intel i5-2540M 2.60-GHz (SC turbo up to 3.30-GHz) processor (3.0-MB L3 cache, dual core, 35 W; includes replacement thermal material)
631956-001	Intel Centrino Advanced-N 6230 WLAN module for use only on computer models equipped with an Intel processor
634433-001	Thermal Material Kit (includes replacement thermal paste and pads)
634687-001	AMD Phenom II P650 2.60-GHz processor (2.0-MB L2 cache, 1066-MHz, 3.6GT/sec, triple core, 25 W; includes replacement thermal material)
634688-001	AMD Phenom II P860 2.00-GHz processor (1.5-MB L2 cache, 1333-MHz, 3.6GT/sec, triple core, 25 W; includes replacement thermal material)
634689-001	AMD Phenom II P960 1.80-GHz processor (2.0-MB L2 cache, 1066-MHz, 3.6GT/sec, quad core, 25 W; includes replacement thermal material)
634691-001	AMD Turion II P560 2.50-GHz processor (2.0-MB L2 cache, 1066-MHz, 3.6GT/sec, dual core, 25 W; includes replacement thermal material)
634692-001	Intel i3-390M 2.66-GHz processor (3.0-MB L3 cache, dual core, 35 W; includes replacement thermal material)
634693-001	Intel i5-480M 2.66-GHz (SC turbo up to 2.93-GHz) processor (3.0-MB L3 cache, dual core, 35 W; includes replacement thermal material)
635494-001	AMD Phenom II N660 3.00-GHz processor (2.0-MB L2 cache, 1333-MHz, 3.6GT/sec, dual core, 35 W; includes replacement thermal material)
635495-001	AMD Phenom II N870 2.30-GHz processor (1.5-MB L2 cache, 1333-MHz, 3.6GT/sec, triple core, 35 W; includes replacement thermal material)

<b>Spare part number</b>	<b>Description</b>
635496-001	AMD Phenom II N970 2.20-GHz processor (2.0-MB L2 cache, 1333-MHz, 3.6GT/sec, quad core, 35 W; includes replacement thermal material)
635500-001	Intel Pentium P6300 2.26-GHz processor (3.0-MB L3 cache, dual core, 35 W; includes replacement thermal material)
636370-001	System board for use only with computer models equipped with an Intel processor, HM55 chipset, and a graphics subsystem with UMA video memory (includes replacement thermal material)
636371-001	System board for use only with computer models equipped with an Intel processor, HM55 chipset, and a graphics subsystem with 512-MB of discrete video memory (includes replacement thermal material)
636372-001	System board for use only with computer models equipped with an Intel processor, HM55 chipset, and a graphics subsystem with 1024-MB of discrete video memory (includes replacement thermal material)
636373-001	System board for use only with computer models equipped with an Intel processor, HM65 chipset, and a graphics subsystem with UMA video memory (includes replacement thermal material)
636374-001	System board for use only with computer models equipped with an Intel processor, HM65 chipset, and a graphics subsystem with 512-MB of discrete video memory (includes replacement thermal material)
636375-001	System board for use only with computer models equipped with an Intel processor, HM65 chipset, and a graphics subsystem with 512-MB of discrete video memory (includes replacement thermal material)
636634-001	AMD V160 2.40-GHz processor (512-KB L2 cache, 1066-MHz 3.2-GT/sec, single core, 25 W; includes replacement thermal material)
636635-001	AMD Athlon II P360 2.30-GHz processor (1.0-MB L2 cache, 1066-MHz, 3.2GT/sec, dual core, 25 W; includes replacement thermal material)
637189-001	System board for use only with computer models equipped with an Intel processor, HM55 chipset, and a graphics subsystem with UMA video memory (includes replacement thermal material)
637190-001	System board for use only with computer models equipped with an Intel processor, HM55 chipset, and a graphics subsystem with discrete video memory (includes replacement thermal material)
637193-001	RTC battery (includes cable and double-sided tape)
637197-001	Webcam/microphone module
637312-001	640-GB, 5400-rpm hard drive (2.5-in, SATA, does not include isolators or shield)
638037-001	Intel i3-2310M 2.10-GHz processor (3.0-MB L3 cache, dual core, 35 W; includes replacement thermal material)
638039-001	Intel i5-2410M 2.30-GHz (SC turbo up to 2.90-GHz) processor (3.0-MB L3 cache, dual core, 35 W; includes replacement thermal material)
638854-001	System board for use only with computer models equipped with an AMD Athlon, Phenom, Turion, or V-series processor and a graphics subsystem with 512-MB of discrete video memory (includes replacement thermal material)
638855-001	System board for use only with computer models equipped with an AMD Athlon, Phenom, Turion, or V-series processor and a graphics subsystem with 1024-MB of discrete video memory (includes replacement thermal material)

<b>Spare part number</b>	<b>Description</b>
638856-001	System board for use only with computer models equipped with an AMD Athlon, Phenom, Turion, or V-series processor and a graphics subsystem with UMA video memory (includes replacement thermal material)
639444-001	Hard Drive Hardware Kit (includes front and rear isolators and shield)
639455-001	Rubber Feet Kit (includes 4 rubber feet)
639460-001	Fan (includes replacement thermal material)
639462-001	Heat sink for use only with computer models equipped with an AMD Athlon, Phenom, Turion, or V-series processor and a graphics subsystem with discrete video memory (includes replacement thermal material)
639463-001	Heat sink for use only with computer models equipped with an AMD Athlon, Phenom, Turion, or V-series processor and a graphics subsystem with UMA video memory (includes replacement thermal material)
639736-001	1-GB memory module (DDR3, 10600, 1333-MHz)
640192-001	Antenna Kit (includes left and right wireless antenna cables and transceivers)
640193-001	Top cover in Sonoma red finish (includes TouchPad and TouchPad cable)
640194-001	Display enclosure in Sonoma red finish
640195-001	Display enclosure in Pacific blue finish
640196-001	Display enclosure in sweet purple finish
640197-001	Display enclosure in butter gold finish
640198-001	Display enclosure in ocean drive finish
640199-001	Display enclosure in luminous rose finish
640200-001	Display enclosure in charcoal gray finish
640201-001	Display enclosure in pewter finish
640202-001	Display enclosure in pearl pink finish
640203-001	Base enclosure (includes battery release latch, heat sink, replacement thermal material, and 4 rubber feet)
640204-001	Display bezel
640205-001	Display Cable Kit (includes display panel cable and webcam/microphone module cable)
640206-001	Cable Kit (includes hard drive connector cable, optical drive cable, and TouchPad cable)
	<b>NOTE:</b> See <a href="#">Cable Kit on page 27</a> for more Cable Kit spare part information.
640207-001	Display Hinge Kit (includes left and right display hinges and brackets)
640208-001	Keyboard in black finish for use in the United States (includes keyboard cable)
640208-031	Keyboard in black finish for use in the United Kingdom and Singapore (includes keyboard cable)
640208-041	Keyboard in black finish for use in Germany (includes keyboard cable)
640208-051	Keyboard in black finish for use in France (includes keyboard cable)

<b>Spare part number</b>	<b>Description</b>
640208-061	Keyboard in black finish for use in Italy (includes keyboard cable)
640208-071	Keyboard in black finish for use in Spain (includes keyboard cable)
640208-121	Keyboard in black finish for use in Canada (includes keyboard cable)
640208-131	Keyboard in black finish for use in Portugal (includes keyboard cable)
640208-141	Keyboard in black finish for use in Turkey (includes keyboard cable)
640208-171	Keyboard in black finish for use in Saudi Arabia (includes keyboard cable)
640208-211	Keyboard in black finish for use in Hungary (includes keyboard cable)
640208-221	Keyboard in black finish for use in the Czech Republic (includes keyboard cable)
640208-251	Keyboard in black finish for use in Russia (includes keyboard cable)
640208-261	Keyboard in black finish for use in Bulgaria (for use only with computer models equipped with an AMD processor; includes keyboard cable)
640208-A41	Keyboard in black finish for use in Belgium (includes keyboard cable)
640208-B31	Keyboard in black finish for use in the Netherlands (includes keyboard cable)
640208-BA1	Keyboard in black finish for use in Slovenia (includes keyboard cable)
640208-BB1	Keyboard in black finish for use in Israel (includes keyboard cable)
640208-BG1	Keyboard in black finish for use in Switzerland (includes keyboard cable)
640208-DH1	Keyboard in black finish for use in Denmark, Finland, and Norway (includes keyboard cable)
640208-DJ1	Keyboard in black finish for use in Greece (includes keyboard cable)
640209-001	DVD±RW and CD-RW Super Multi Double-Layer Combo Drive with LightScribe
640210-001	Blu-ray ROM with LightScribe DVD±R/RW Super Multi Double-Layer Drive
640211-001	USB board (includes cable)
640212-001	Power button board (includes cable)
640213-001	TouchPad LED board (includes cable)
640214-001	TouchPad button board (includes cable)
640215-001	LED board (includes cable)
640216-001	Plastics Kit (includes the service cover)
640217-001	Screw Kit
640218-001	Display Screw Kit
640220-001	17.3-in, HD, LED, BrightView display assembly in Sonoma red finish (includes webcam, two microphones, and wireless antenna transceivers and cables)
640221-001	17.3-in, HD, LED, BrightView display assembly in Pacific blue finish (includes webcam, two microphones, and wireless antenna transceivers and cables)
640222-001	17.3-in, HD, LED, BrightView display assembly in sweet purple finish (includes webcam, two microphones, and wireless antenna transceivers and cables)

<b>Spare part number</b>	<b>Description</b>
640223-001	17.3-in, HD, LED, BrightView display assembly in butter gold finish (includes webcam, two microphones, and wireless antenna transceivers and cables)
640224-001	17.3-in, HD, LED, BrightView display assembly in ocean drive finish (includes webcam, two microphones, and wireless antenna transceivers and cables)
640225-001	17.3-in, HD, LED, BrightView display assembly in luminous rose finish (includes webcam, two microphones, and wireless antenna transceivers and cables)
640226-001	17.3-in, HD, LED, BrightView display assembly in charcoal gray finish (includes webcam, two microphones, and wireless antenna transceivers and cables)
640227-001	17.3-in, HD, LED, BrightView display assembly in pewter finish (includes webcam, two microphones, and wireless antenna transceivers and cables)
640228-001	17.3-in, HD, LED, BrightView display assembly in pearl pink finish (includes webcam, two microphones, and wireless antenna transceivers and cables)
640926-001	Realtek RTL8191SE 802.11b/g/n 1×1 WiFi Adapter for use only with computer models equipped with an AMD processor
641140-001	Heat sink for use only with computer models equipped with an Intel processor, the HM65 chipset, and a graphics subsystem with UMA video memory (includes replacement thermal material)
641141-001	Heat sink for use only with computer models equipped with an Intel processor, the HM65 chipset, and a graphics subsystem with discrete video memory (includes replacement thermal material)
641394-001	Power connector cable
641395-001	17.3-in, HD, LED, BrightView display panel
641396-001	Speaker Kit (includes left and right speakers and cable)
641399-001	Top cover in Pacific blue finish (includes TouchPad and TouchPad cable)
641400-001	Top cover in sweet purple finish (includes TouchPad and TouchPad cable)
641401-001	Top cover in butter gold finish (includes TouchPad and TouchPad cable)
641402-001	Top cover in ocean drive finish (includes TouchPad and TouchPad cable)
641403-001	Top cover in luminous rose finish (includes TouchPad and TouchPad cable)
641404-001	Top cover in charcoal gray finish (includes TouchPad and TouchPad cable)
641405-001	Top cover in pewter finish (includes TouchPad and TouchPad cable)
641406-001	Top cover in pearl pink finish (includes TouchPad and TouchPad cable)
643698-001	Display hinge covers
644351-001	750-GB, 5400-rpm hard drive (2.5-in, 7.0-mm, SATA, does not include hard drive connector cable, isolators, or shield)
644685-001	500-GB, 7200-rpm hard drive (2.5-in, 7.0-mm, SATA, does not include hard drive connector cable, isolators, or shield)
645086-001	320-GB, 5400-rpm hard drive (2.5-in, 7.0-mm, SATA, does not include hard drive connector cable, isolators, or shield)
645089-001	320-GB, 7200-rpm hard drive (2.5-in, 7.0-mm, SATA, does not include hard drive connector cable, isolators, or shield)

<b>Spare part number</b>	<b>Description</b>
645091-001	250-GB, 7200-rpm hard drive (2.5-in, 7.0-mm, SATA, does not include hard drive connector cable, isolators, or shield)
647626-001	System board for use only with computer models equipped with the AMD RS880MD chipset, an AMD processor, and a graphics subsystem with 512-MB of discrete video memory (includes replacement thermal material)
647627-001	System board for use only with computer models equipped with the AMD RS880MD chipset, an AMD processor, and a graphics subsystem with 1024-MB of discrete video memory (includes replacement thermal material)
647630-001	Keyboard in silver finish for use in the United States (includes keyboard cable)
647630-031	Keyboard in silver finish for use in the United Kingdom and Singapore (includes keyboard cable)
647630-041	Keyboard in silver finish for use in Germany (includes keyboard cable)
647630-051	Keyboard in silver finish for use in France (includes keyboard cable)
647630-061	Keyboard in silver finish for use in Italy (includes keyboard cable)
647630-071	Keyboard in silver finish for use in Spain (includes keyboard cable)
647630-121	Keyboard in silver finish for use in Canada (includes keyboard cable)
647630-131	Keyboard in silver finish for use in Portugal (includes keyboard cable)
647630-141	Keyboard in silver finish for use in Turkey (includes keyboard cable)
647630-171	Keyboard in silver finish for use in Saudi Arabia (includes keyboard cable)
647630-211	Keyboard in silver finish for use in Hungary (includes keyboard cable)
647630-221	Keyboard in silver finish for use in the Czech Republic (includes keyboard cable)
647630-251	Keyboard in silver finish for use in Russia (includes keyboard cable)
647630-261	Keyboard in silver finish for use in Bulgaria (for use only with computer models equipped with an AMD processor; includes keyboard cable)
647630-A41	Keyboard in silver finish for use in Belgium (includes keyboard cable)
647630-B31	Keyboard in silver finish for use in the Netherlands (includes keyboard cable)
647630-BA1	Keyboard in silver finish for use in Slovenia (includes keyboard cable)
647630-BB1	Keyboard in silver finish for use in Israel (includes keyboard cable)
647630-BG1	Keyboard in silver finish for use in Switzerland (includes keyboard cable)
647630-DH1	Keyboard in silver finish for use in Denmark, Finland, and Norway (includes keyboard cable)
647630-DJ1	Keyboard in silver finish for use in Greece (includes keyboard cable)
647630-FL1	Keyboard in silver finish for use in the Slovakia (for use only with computer models equipped with an Intel processor; includes keyboard cable)
649948-001	System board for use only with computer models equipped with the AMD A60M chipset, an AMD processor, and a graphics subsystem with UMA video memory (includes replacement thermal material)

<b>Spare part number</b>	<b>Description</b>
649949-001	System board for use only with computer models equipped with the AMD A60M chipset, an AMD processor, and a graphics subsystem with 512-MB of discrete video memory (includes replacement thermal material)
649950-001	System board for use only with computer models equipped with the AMD A60M chipset, an AMD processor, and a graphics subsystem with 1024-MB of discrete video memory (includes replacement thermal material)
649952-001	Heat sink for use only with computer models equipped with the AMD RS880MD chipset, an AMD processor, and a graphics subsystem with discrete video memory (includes replacement thermal material)
649953-001	Heat sink for use only with computer models equipped with the AMD A60M chipset, an AMD processor, and a graphics subsystem with discrete video memory (includes replacement thermal material)
649954-001	Heat sink for use only with computer models equipped with the AMD A60M chipset, an AMD processor, and a graphics subsystem with UMA video memory (includes replacement thermal material)
650198-001	System board for use only with computer models equipped with the Intel HM65 chipset, an Intel processor, and a graphics subsystem with 512-MB of discrete video memory and supports bus alive/chip off (BACO; includes replacement thermal material)
650199-001	System board for use only with computer models equipped with the Intel HM65 chipset, an Intel processor, and a graphics subsystem with 1024-MB of discrete video memory and supports bus alive/chip off (BACO; includes replacement thermal material)
653337-001	Intel Pentium B940 TJ85 2.00-GHz processor (2.0-MB L3 cache, dual core 35 W; includes replacement thermal material)
653338-001	Intel Pentium B950 TJ85 2.10-GHz processor (2.0-MB L3 cache, dual core 35 W; includes replacement thermal material)
653339-001	Intel core i3-2330M 2.20-GHz processor (1333-MHz FSB, 3.0-MB L3 cache, dual core, 35 W; includes replacement thermal material)
653340-001	Intel Core i3-2350M 2.30-GHz processor (1333-MHz FSB, 3.0-MB L3 cache, dual core, 35 W; includes replacement thermal material)
653341-001	Intel Core i5-2430M 2.40-GHz processor (turbo up to 3.00-GHz; 1333-MHz, 3.0-MB L3 cache, dual core, 35 W; includes replacement thermal material)
653348-001	AMD A4-3300M 2.50-GHz processor (1.9-GHz FSB, 4.0-MB L2 cache, dual core, 35 W; includes replacement thermal material)
653349-001	AMD A6-3400M 2.30-GHz processor (1.4-GHz FSB, 4.0-MB L2 cache, quad core, 35 W; includes replacement thermal material)
653350-001	AMD A8-3500M 2.40-GHz processor (1.5-GHz FSB, 4.0-MB L2 cache, quad core, 35 W; includes replacement thermal material)
654117-001	System board equipped with an Intel Core i3-370M 2.40-GHz processor (3.0-MB L3 cache, dual core, 35 W), the HM55 chipset, and a graphics subsystem with 1024-MB of discrete video memory (includes replacement thermal material)
654118-001	System board equipped with an Intel Core i3-370M 2.40-GHz processor (3.0-MB L3 cache, dual core, 35 W), the HM55 chipset, and a graphics subsystem with UMA video memory (includes replacement thermal material)

<b>Spare part number</b>	<b>Description</b>
654119-001	Heat sink for use only with computer models equipped with the Intel HM65 or HM55 chipset, an Intel processor, and a graphics subsystem with discrete video memory (includes replacement thermal material)
654120-001	Heat sink for use only with computer models equipped with the Intel HM65 or HM55 chipset, an Intel processor, and a graphics subsystem with UMA video memory (includes replacement thermal material)
657325-001	Broadcom 4313GN 802.11b/g/n 1×1 WiFi and 20702 Bluetooth 4.0 Combo Adapter
659617-001	Optical drive bay space saver
659877-001	DVD±RW and CD-RW Super Multi Double-Layer Combo Drive with LightScribe
659878-001	Blu-ray ROM with LightScribe DVD±R/RW Super Multi Double-Layer Drive
660773-001	System board for use only with computer models equipped with an AMD Fusion E-450 1.65-GHz processor (dual core, 18 W) and a graphics subsystem with UMA video memory (includes replacement thermal material)



---

# 4 Removal and replacement procedures

## Preliminary replacement requirements

### Tools required

You will need the following tools to complete the removal and replacement procedures:

- Flat-bladed screwdriver
- Magnetic screwdriver
- Phillips P0 and P1 screwdrivers

### Service considerations

The following sections include some of the considerations that you must keep in mind during disassembly and assembly procedures.

---

 **NOTE:** As you remove each subassembly from the computer, place the subassembly (and all accompanying screws) away from the work area to prevent damage.

---

### Plastic parts

---

 **CAUTION:** Using excessive force during disassembly and reassembly can damage plastic parts. Use care when handling the plastic parts. Apply pressure only at the points designated in the maintenance instructions.

---

### Cables and connectors

---

 **CAUTION:** When servicing the computer, be sure that cables are placed in their proper locations during the reassembly process. Improper cable placement can damage the computer.

---

Cables must be handled with extreme care to avoid damage. Apply only the tension required to unseat or seat the cables during removal and insertion. Handle cables by the connector whenever possible. In all cases, avoid bending, twisting, or tearing cables. Be sure that cables are routed in such a way that they cannot be caught or snagged by parts being removed or replaced. Handle flex cables with extreme care; these cables tear easily.

## Drive handling

---

**⚠ CAUTION:** Drives are fragile components that must be handled with care. To prevent damage to the computer, damage to a drive, or loss of information, observe these precautions:

Before removing or inserting a hard drive, shut down the computer. If you are unsure whether the computer is off or in Hibernation, turn the computer on, and then shut it down through the operating system.

Before handling a drive, be sure that you are discharged of static electricity. While handling a drive, avoid touching the connector.

Before removing a diskette drive or optical drive, be sure that a diskette or disc is not in the drive and be sure that the optical drive tray is closed.

Handle drives on surfaces covered with at least one inch of shock-proof foam.

Avoid dropping drives from any height onto any surface.

After removing a hard drive, an optical drive, or a diskette drive, place it in a static-proof bag.

Avoid exposing an internal hard drive to products that have magnetic fields, such as monitors or speakers.

Avoid exposing a drive to temperature extremes or liquids.

If a drive must be mailed, place the drive in a bubble pack mailer or other suitable form of protective packaging and label the package "FRAGILE."

---

## Grounding guidelines

### Electrostatic discharge damage

Electronic components are sensitive to electrostatic discharge (ESD). Circuitry design and structure determine the degree of sensitivity. Networks built into many integrated circuits provide some protection, but in many cases, ESD contains enough power to alter device parameters or melt silicon junctions.

A discharge of static electricity from a finger or other conductor can destroy static-sensitive devices or microcircuitry. Even if the spark is neither felt nor heard, damage may have occurred.

An electronic device exposed to ESD may not be affected at all and can work perfectly throughout a normal cycle. Or the device may function normally for a while, then degrade in the internal layers, reducing its life expectancy.

**⚠ CAUTION:** To prevent damage to the computer when you are removing or installing internal components, observe these precautions:

Keep components in their electrostatic-safe containers until you are ready to install them.

Before touching an electronic component, discharge static electricity by using the guidelines described in this section.

Avoid touching pins, leads, and circuitry. Handle electronic components as little as possible.

If you remove a component, place it in an electrostatic-safe container.

the following table shows how humidity affects the electrostatic voltage levels generated by different activities.

**⚠ CAUTION:** A product can be degraded by as little as 700 V.

<b>Typical electrostatic voltage levels</b>			
<b>Event</b>	<b>Relative humidity</b>		
	<b>10%</b>	<b>40%</b>	<b>55%</b>
Walking across carpet	35,000 V	15,000 V	7,500 V
Walking across vinyl floor	12,000 V	5,000 V	3,000 V
Motions of bench worker	6,000 V	800 V	400 V
Removing DIPS from plastic tube	2,000 V	700 V	400 V
Removing DIPS from vinyl tray	11,500 V	4,000 V	2,000 V
Removing DIPS from Styrofoam	14,500 V	5,000 V	3,500 V
Removing bubble pack from PCB	26,500 V	20,000 V	7,000 V
Packing PCBs in foam-lined box	21,000 V	11,000 V	5,000 V

## Packaging and transporting guidelines

Follow these grounding guidelines when packaging and transporting equipment:

- To avoid hand contact, transport products in static-safe tubes, bags, or boxes.
- Protect ESD-sensitive parts and assemblies with conductive or approved containers or packaging.
- Keep ESD-sensitive parts in their containers until the parts arrive at static-free workstations.
- Place items on a grounded surface before removing items from their containers.
- Always be properly grounded when touching a component or assembly.
- Store reusable ESD-sensitive parts from assemblies in protective packaging or nonconductive foam.
- Use transporters and conveyors made of antistatic belts and roller bushings. Be sure that mechanized equipment used for moving materials is wired to ground and that proper materials are selected to avoid static charging. When grounding is not possible, use an ionizer to dissipate electric charges.

## Workstation guidelines

Follow these grounding workstation guidelines:

- Cover the workstation with approved static-shielding material.
- Use a wrist strap connected to a properly grounded work surface and use properly grounded tools and equipment.
- Use conductive field service tools, such as cutters, screwdrivers, and vacuums.
- When fixtures must directly contact dissipative surfaces, use fixtures made only of static-safe materials.
- Keep the work area free of nonconductive materials, such as ordinary plastic assembly aids and Styrofoam.
- Handle ESD-sensitive components, parts, and assemblies by the case or PCM laminate. Handle these items only at static-free workstations.
- Avoid contact with pins, leads, or circuitry.
- Turn off power and input signals before inserting or removing connectors or test equipment.

## Equipment guidelines

Grounding equipment must include either a wrist strap or a foot strap at a grounded workstation.

- When seated, wear a wrist strap connected to a grounded system. Wrist straps are flexible straps with a minimum of one megohm  $\pm 10\%$  resistance in the ground cords. To provide proper ground, wear a strap snugly against the skin at all times. On grounded mats with banana-plug connectors, use alligator clips to connect a wrist strap.
- When standing, use foot straps and a grounded floor mat. Foot straps (heel, toe, or boot straps) can be used at standing workstations and are compatible with most types of shoes or boots. On conductive floors or dissipative floor mats, use foot straps on both feet with a minimum of one megohm resistance between the operator and ground. To be effective, the conductive must be worn in contact with the skin.

The following grounding equipment is recommended to prevent electrostatic damage:

- Antistatic tape
- Antistatic smocks, aprons, and sleeve protectors
- Conductive bins and other assembly or soldering aids
- Nonconductive foam
- Conductive tabletop workstations with ground cords of one megohm resistance
- Static-dissipative tables or floor mats with hard ties to the ground
- Field service kits
- Static awareness labels
- Material-handling packages
- Nonconductive plastic bags, tubes, or boxes
- Metal tote boxes
- Electrostatic voltage levels and protective materials

The following table lists the shielding protection provided by antistatic bags and floor mats.

<b>Material</b>	<b>Use</b>	<b>Voltage protection level</b>
Antistatic plastics	Bags	1,500 V
Carbon-loaded plastic	Floor mats	7,500 V
Metallized laminate	Floor mats	5,000 V

# Component replacement procedures

This chapter provides removal and replacement procedures.

There are as many as 51 screws that must be removed, replaced, or loosened when servicing the computer. Make special note of each screw size and location during removal and replacement.

## Service tag

When ordering parts or requesting information, provide the computer serial number and model number provided on the service tag.

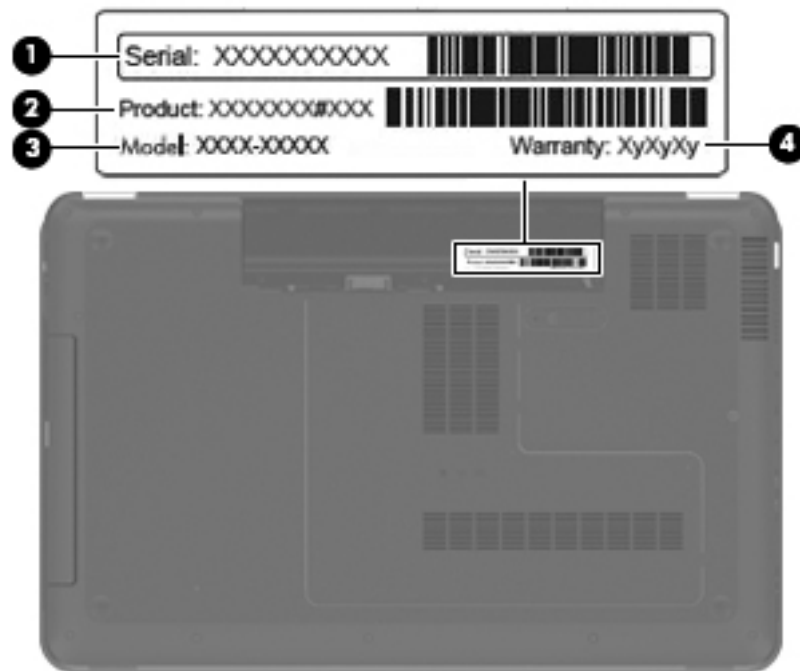

Item	Description	Function
(1)	Serial number (s/n)	This is an alphanumeric identifier that is unique to each product.
(2)	Part number/Product number (p/n)	This number provides specific information about the product's hardware components. The part number helps a service technician to determine what components and parts are needed.
(3)	Model description:	This is the alphanumeric identifier needed to locate documents, drivers, and support for the computer.
(4)	Warranty period	This number describes the duration of the warranty period for the computer.

## Computer feet

The computer feet are adhesive-backed rubber pads. The feet are included in the Rubber Feet Kit, spare part number 639455-001. There are 4 rubber feet that attach to the base enclosure in the locations illustrated below.

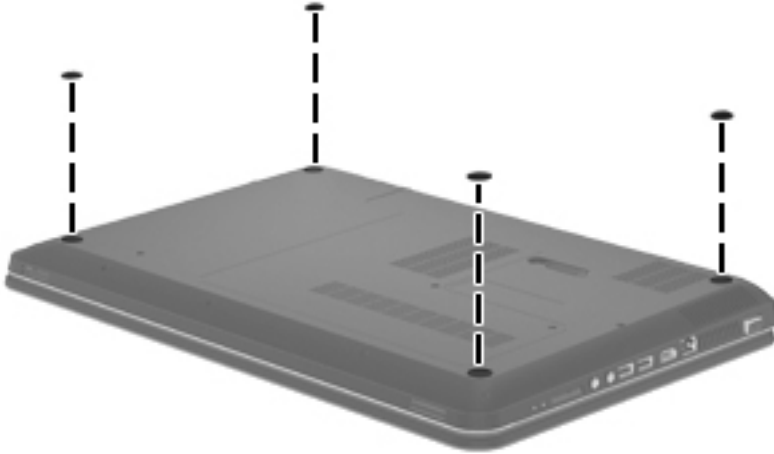

## Battery

Description	Spare part number
6-cell, 55-Whr, 2.55-Ah Li-ion battery	593554-001
6-cell, 47-Whr, 2.20-Ah Li-ion battery	593553-001

Before disassembling the computer, follow these steps:

1. Shut down the computer. If you are unsure whether the computer is off or in Hibernation, turn the computer on, and then shut it down through the operating system.
2. Disconnect all external devices connected to the computer.
3. Disconnect the power from the computer by first unplugging the power cord from the AC outlet and then unplugging the AC adapter from the computer.

Remove the battery:

1. Slide the battery release latch **(1)** to release the battery.
2. Pivot the front edge of the battery **(2)** up and back.

3. Remove the battery **(3)** from the computer.

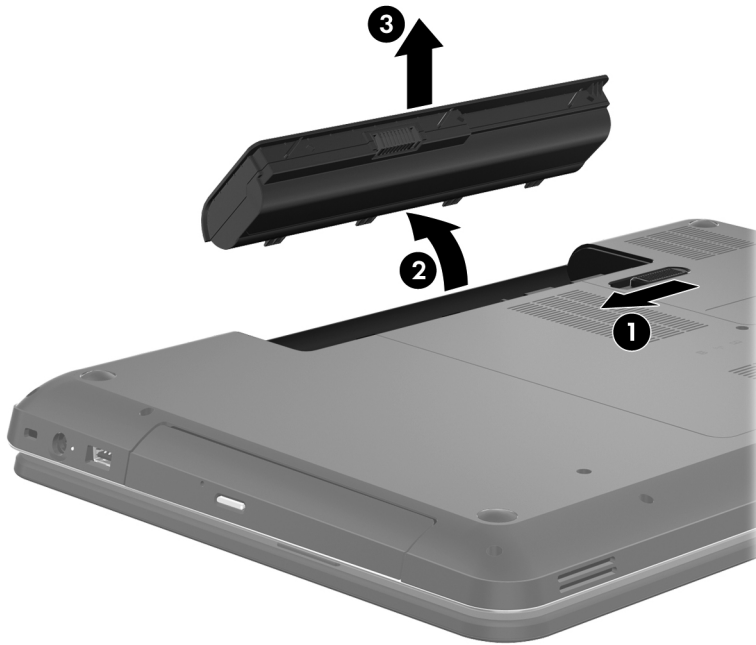

To insert the battery:

1. Align the tabs on the rear edge of the battery with the notches on the rear edge of the battery bay.
2. Pivot the front edge of the battery down into the battery bay until it is seated. (The battery release latch will automatically lock into place.)



## Optical drive

 **NOTE:** The optical drive spare part kit includes a bezel and bracket.

Description	Spare part number
Blu-ray ROM with LightScribe DVD $\pm$ R/RW Super Multi Double-Layer Drive	640210-001 and 659878-001
DVD $\pm$ RW and CD-RW Super Multi Double-Layer Combo Drive with LightScribe	640209-001 and 659877-001
Optical drive bay space saver	659617-001

Before removing the optical drive, follow these steps:

1. Shut down the computer. If you are unsure whether the computer is off or in Hibernation, turn the computer on, and then shut it down through the operating system.
2. Disconnect all external devices connected to the computer.
3. Disconnect the power from the computer by first unplugging the power cord from the AC outlet and then unplugging the AC adapter from the computer.
4. Remove the battery (see [Battery on page 47](#)).

Remove the optical drive:

1. Loosen the two captive screws **(1)** that secure the service cover to the computer.
2. Lift the rear edge of the service cover **(2)** up and forward until it rests at an angle.

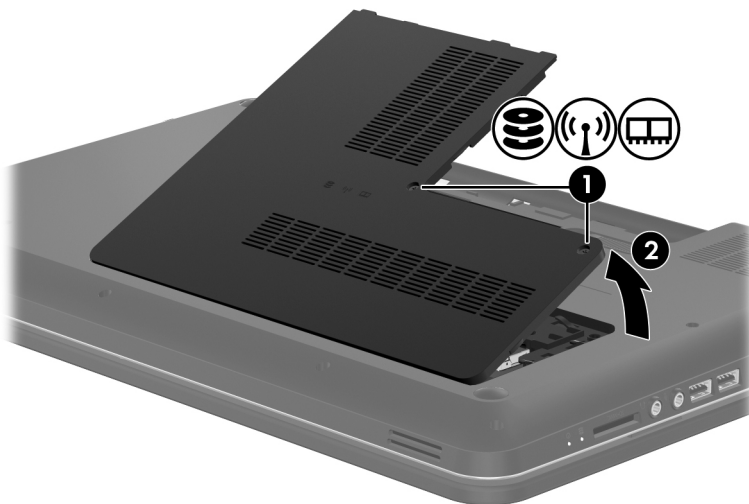

3. Remove the service cover. The service cover is available in the Plastics Kit, spare part number 640216-001.
4. Remove the Phillips PM2.5 $\times$ 4.0 screw **(1)** that secures the optical drive to the computer.

5. Remove the optical drive **(2)** by sliding it out of the optical drive bay.

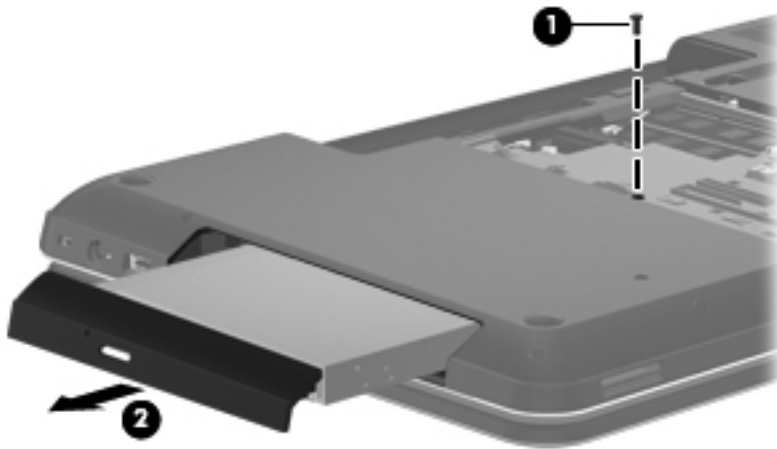

6. If it is necessary to replace the optical drive bracket, position the optical drive with the rear panel toward you.
7. Remove the two Phillips PM2.0×4.0 screws **(1)** that secure the bracket to the optical drive.
8. Remove the optical drive bracket **(2)**.

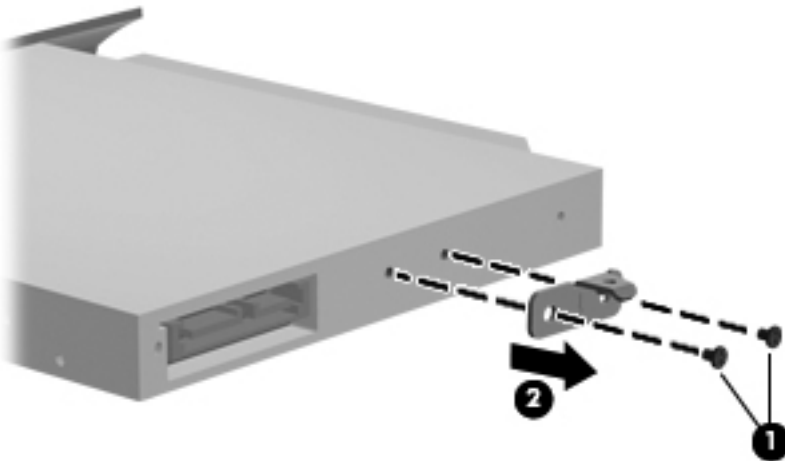

Reverse this procedure to reassemble and install the optical drive.

## Hard drive

 **NOTE:** The hard drive spare part kit does not include the hard drive connector cable, isolators, or shield. The hard drive connector cable, isolators, and shield are included in the Hard Drive Hardware Kit, spare part number 639444-001. The hard drive connector cable is included in the Cable Kit, spare part number 640206-001.

Description	Spare part number
For use with all computer models:	
750-GB, 5400-rpm	644351-001
640-GB, 5400-rpm	637312-001
500-GB, 7200-rpm	644685-001
320-GB, 7200-rpm	645089-001
320-GB, 5400-rpm	645086-001
250-GB, 7200-rpm	645091-001

Before removing the hard drive, follow these steps:

1. Shut down the computer. If you are unsure whether the computer is off or in Hibernation, turn the computer on, and then shut it down through the operating system.
2. Disconnect all external devices connected to the computer.
3. Disconnect the power from the computer by first unplugging the power cord from the AC outlet and then unplugging the AC adapter from the computer.
4. Remove the battery (see [Battery on page 47](#)).
5. Remove the service cover (see [Optical drive on page 49](#)).

Remove the hard drive:

1. Disconnect the hard drive connector cable **(1)** from the system board.

2. Lift the front edge of the hard drive **(2)** until it rests at an angle.

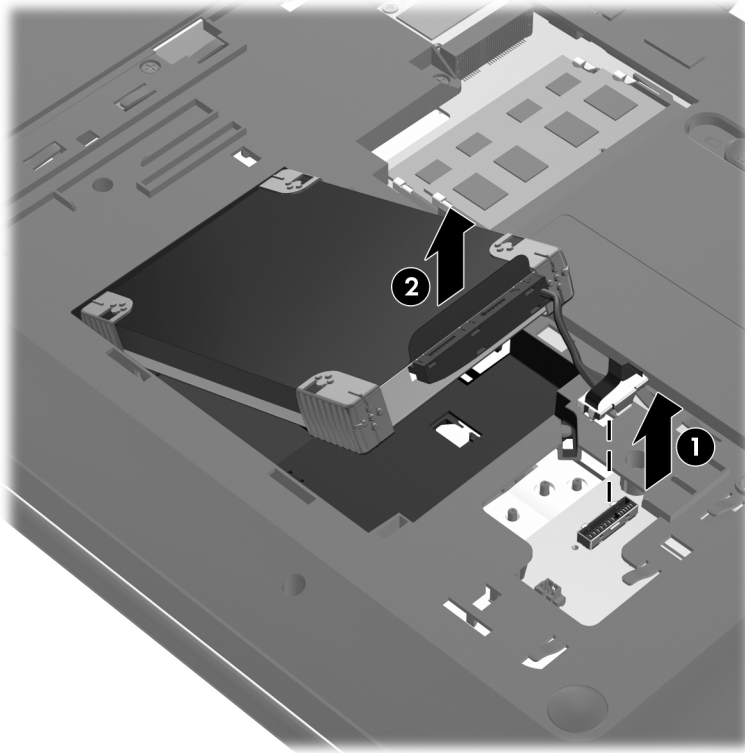

3. Remove the hard drive.
4. If it is necessary to replace the hard drive connector cable **(1)**, the hard drive isolators **(2)**, or the shield **(3)** from the hard drive, remove and replace the components.

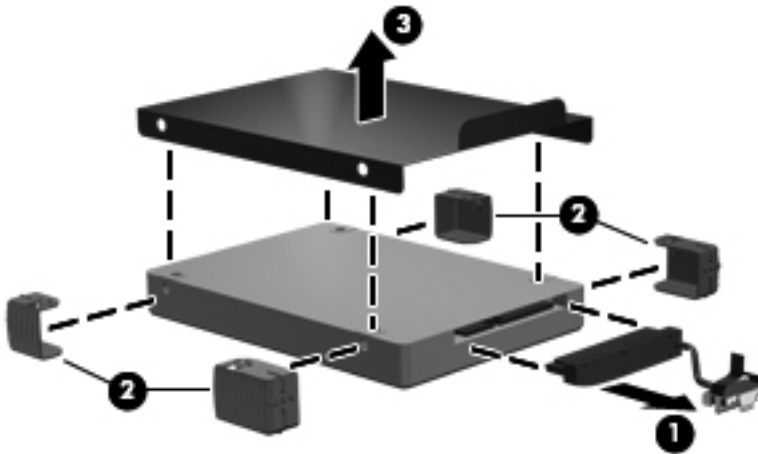

Reverse this procedure to reassemble and install the mass storage device.

## RTC battery

Description	Spare part number
RTC battery (includes cable and double-sided tape)	637193-001

Before removing the RTC battery, follow these steps:

1. Shut down the computer. If you are unsure whether the computer is off or in Hibernation, turn the computer on, and then shut it down through the operating system.
2. Disconnect all external devices connected to the computer.
3. Disconnect the power from the computer by first unplugging the power cord from the AC outlet and then unplugging the AC adapter from the computer.
4. Remove the battery (see [Battery on page 47](#)).
5. Remove the service cover (see [Optical drive on page 49](#)).

Remove the RTC battery:

1. Disconnect the RTC battery cable **(1)** from the system board.
2. Slide the RTC battery **(2)** out from under the surface of the base enclosure.
3. Remove the RTC battery **(3)** from the system board. (The RTC battery is attached to the system board with double-sided tape.)

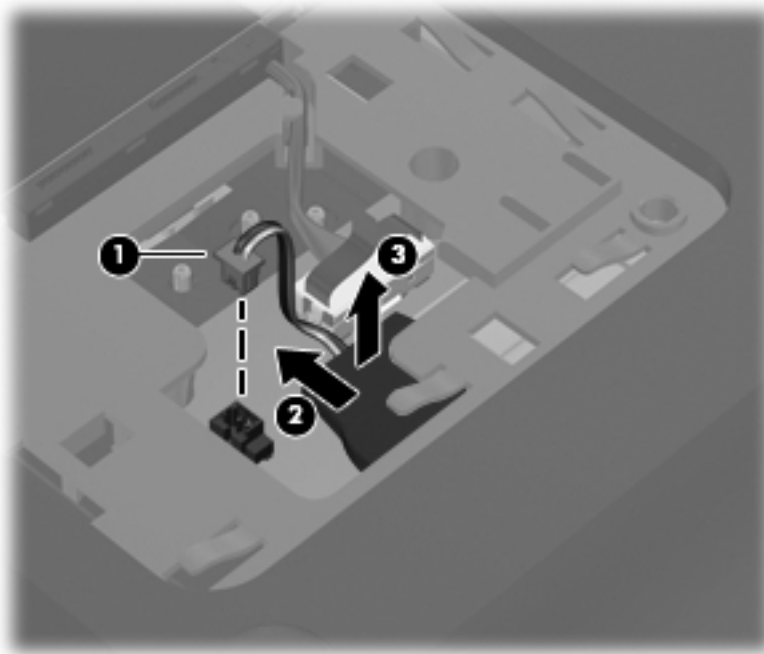

Reverse this procedure to install the RTC battery.

## Memory module

Description	Spare part number
4-GB (DDR3, 10600, 1333-MHz)	621569-001
2-GB (DDR3, 10600, 1333-MHz)	621565-001
1-GB (DDR3, 10600, 1333-MHz)	639736-001

Before removing a memory module, follow these steps:

1. Shut down the computer. If you are unsure whether the computer is off or in Hibernation, turn the computer on, and then shut it down through the operating system.
2. Disconnect all external devices connected to the computer.
3. Disconnect the power from the computer by first unplugging the power cord from the AC outlet and then unplugging the AC adapter from the computer.
4. Remove the battery (see [Battery on page 47](#)).
5. Remove the service cover (see [Optical drive on page 49](#)).

Remove the memory module:

1. Spread the retaining tabs **(1)** on each side of the memory module slot to release the memory module. (The memory module tilts up.)
2. Remove the memory module **(2)** by pulling it away from the slot at an angle.

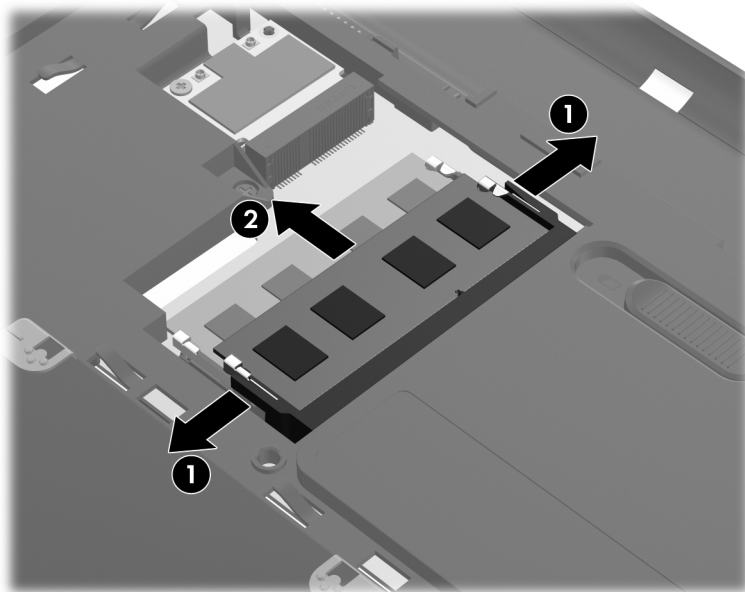

Reverse this procedure to install a memory module.

## WLAN module

Description	Spare part number
For use on all computer models:	
Broadcom 4313 802.11b/g/n 1x1 WiFi and 2070 Bluetooth 2.1+EDR Combo adapter (BT3.0+HS ready)	600370-001
Ralink 5390GN 802.11b/g/n 1x1 WiFi Adapter	630703-001
Ralink RT3090BC4 802.11b/g/n 1x1 WiFi and Bluetooth 2.1+EDR Combo Adapter (BT3.0+HS ready)	630705-001
For use only with computer models equipped with an AMD processor:	
Atheros 9285G 802.11b/g/n 1x1 WiFi Adapter	605560-005
Atheros AR8002WB-1NGB 802.11b/g/n 1x1 WiFi and Bluetooth 2.1+EDR Combo Adapter (BT3.0+HS ready)	593127-001
Broadcom 4313 802.11b/g/n 1x1 WiFi Adapter	593836-001
Broadcom 4313GN 802.11b/g/n 1x1 WiFi and 20702 Bluetooth 4.0 Combo Adapter	657325-001
Realtek RTL8191SE 802.11b/g/n 1x1 WiFi Adapter	640926-001
Realtek 8188BC8 802.11a/b/g/n 2x2 WiFi and Bluetooth 3.0+HS Combo Adapter	602993-001
For use only with computer models equipped with an Intel processor:	
Atheros 9285G 802.11b/g/n 1x1 WiFi Adapter	518436-001
Intel Centrino Advanced-N 6230	631956-001
Intel Centrino Wireless-N 1000	593530-001

**⚠ CAUTION:** To prevent an unresponsive system, replace the wireless module only with a wireless module authorized for use in the computer by the governmental agency that regulates wireless devices in your country or region. If you replace the module and then receive a warning message, remove the module to restore device functionality, and then contact technical support.

Before removing the WLAN module, follow these steps:

1. Shut down the computer. If you are unsure whether the computer is off or in Hibernation, turn the computer on, and then shut it down through the operating system.
2. Disconnect all external devices connected to the computer.
3. Disconnect the power from the computer by first unplugging the power cord from the AC outlet and then unplugging the AC adapter from the computer.
4. Remove the battery (see [Battery on page 47](#)).
5. Remove the service cover (see [Optical drive on page 49](#)).

Remove the WLAN module:

1. Disconnect the WLAN antenna cables **(1)** from the terminals on the WLAN module.

 **NOTE:** The 1/black WLAN antenna cable is connected to the WLAN module 1/Main terminal. The 2/gray WLAN antenna cable is connected to the WLAN module 2/Aux terminal.

2. Remove the Phillips PM2.5×6.0 screw **(2)** that secures the WLAN module to the system board. (The WLAN module tilts up **(3)**.)
3. Remove the WLAN module by pulling the module away from the slot at an angle **(4)**.

 **NOTE:** The WLAN module is designed with a notch **(5)** to prevent incorrect installation into the WLAN module socket.

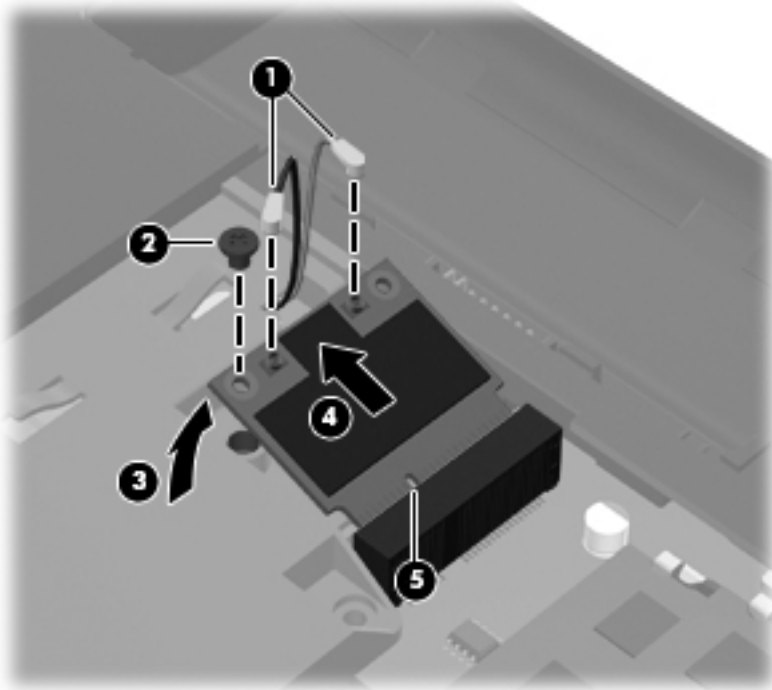

 **NOTE:** If the WLAN antennas are not connected to the terminals on the WLAN module, the protective sleeves must be installed on the antenna connectors, as shown in the following illustration.

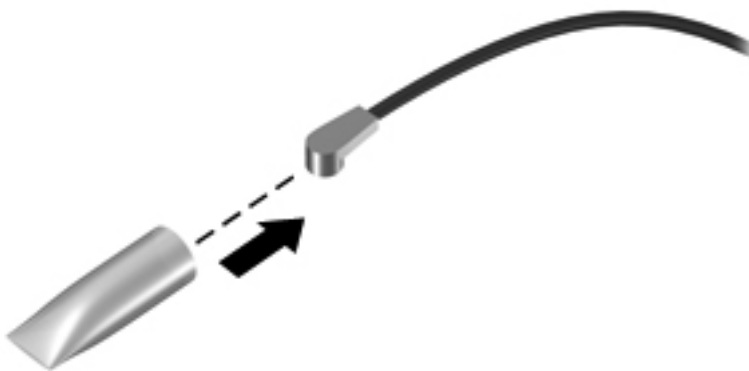

Reverse this procedure to install the WLAN module.



# Keyboard



**NOTE:** The keyboard spare part kit includes a keyboard cable.

Description	Spare part number	Description	Spare part number
Keyboard in black finish:			
For use in Belgium	640208-A41	For use in the Netherlands	640208-B31
For use in Bulgaria (for use only with computer models equipped with an AMD processor)	640208-261	For use in Portugal	640208-131
For use in Canada	640208-121	For use in Russia	640208-251
For use in the Czech Republic	640208-221	For use in Saudi Arabia	640208-171
For use in Denmark, Finland, and Norway	640208-DH1	For use in Slovenia	640208-BA1
For use in France	640208-051	For use in Spain	640208-071
For use in Germany	640208-041	For use in Switzerland	640208-BG1
For use in Greece	640208-DJ1	For use in Turkey	640208-141
For use in Hungary	640208-211	For use in the United Kingdom	640208-031
For use in Israel	640208-BB1	For use in the United States	640208-001
For use in Italy	640208-061		
Keyboard in silver finish:			
For use in Belgium	647630-A41	For use in the Netherlands	647630-B31
For use in Bulgaria (for use only with computer models equipped with an AMD processor)	647630-261	For use in Portugal	647630-131
For use in Canada	647630-121	For use in Russia	647630-251
For use in the Czech Republic	647630-221	For use in Saudi Arabia	647630-171
For use in Denmark, Finland, and Norway	647630-DH1	For use in Slovakia (for use only with computer models equipped with an Intel processor)	647630-FL1
For use in France	647630-051	For use in Slovenia	647630-BA1
For use in Germany	647630-041	For use in Spain	647630-071
For use in Greece	647630-DJ1	For use in Switzerland	647630-BG1
For use in Hungary	647630-211	For use in Turkey	647630-141
For use in Israel	647630-BB1	For use in the United Kingdom	647630-031
For use in Italy	647630-061	For use in the United States	647630-001

Before removing the keyboard, follow these steps:

1. Shut down the computer. If you are unsure whether the computer is off or in Hibernation, turn the computer on, and then shut it down through the operating system.
2. Disconnect all external devices connected to the computer.
3. Disconnect the power from the computer by first unplugging the power cord from the AC outlet and then unplugging the AC adapter from the computer.
4. Remove the battery (see [Battery on page 47](#)).
5. Remove the service cover (see [Optical drive on page 49](#)).

Remove the keyboard:

1. Remove the Phillips PM2.5×7.0 screw that secures the keyboard to the computer.

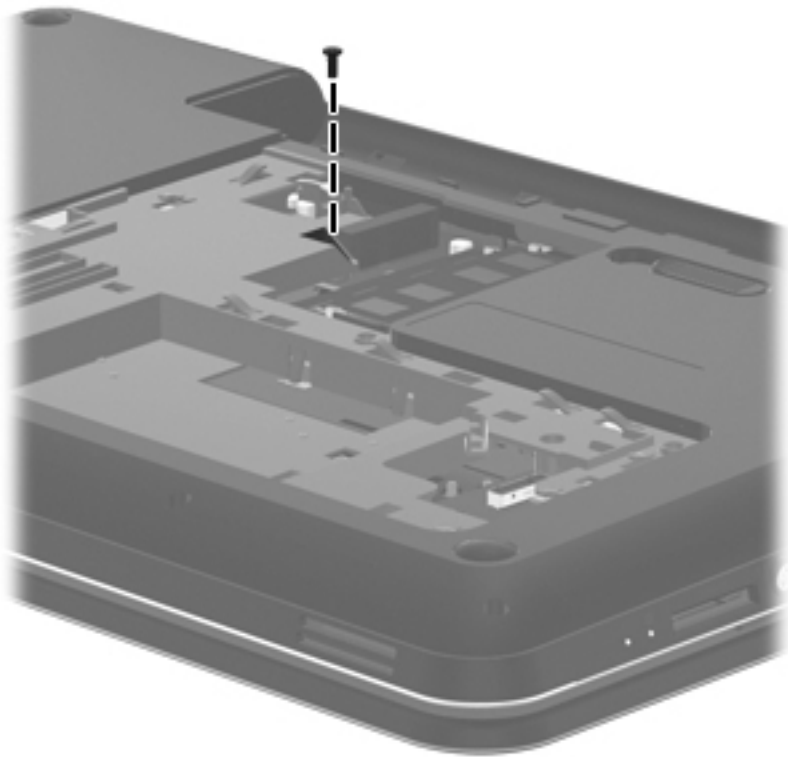

2. Rest the computer on its left side.
3. Open the computer.

4. Insert a screw driver or similar thin tool into the keyboard screw hole, and then press on the back of the keyboard until the keyboard disengages from the computer.

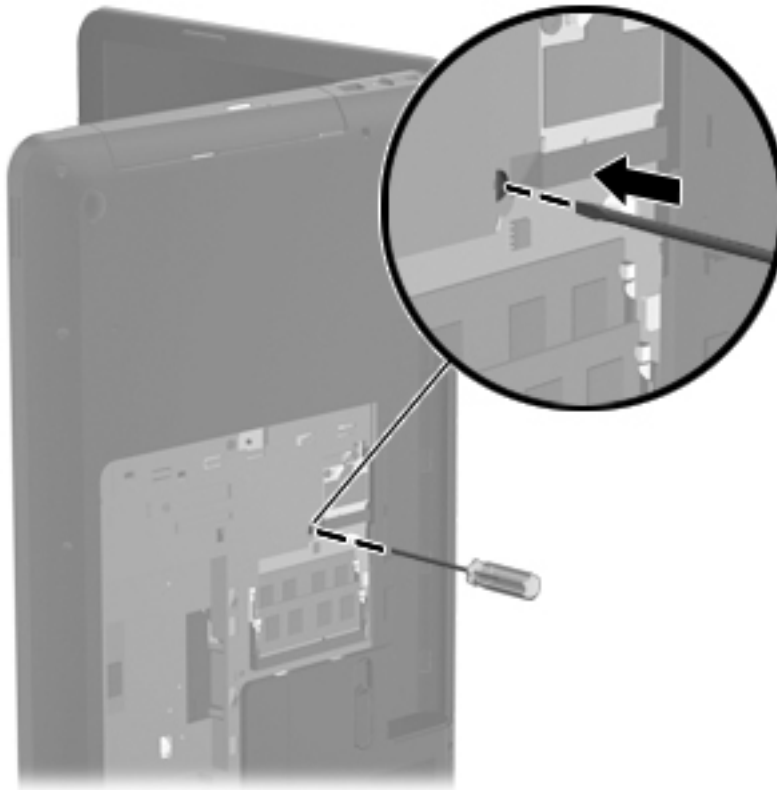

5. Turn the computer right-side up with the front toward you.
6. Lift the rear edge of the keyboard, and then swing the keyboard up and forward until it rests upside down on the palm rest.



7. Release the zero insertion force (ZIF) connector **(1)** to which the keyboard cable is attached, and then disconnect the keyboard cable **(2)** from the system board.

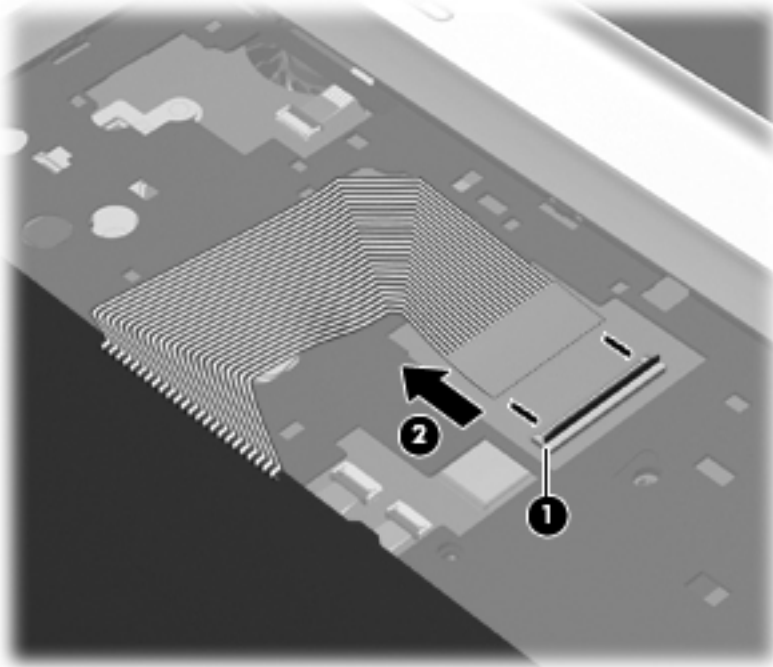

8. Remove the keyboard.

Reverse this procedure to install the keyboard.

## Top cover



**NOTE:** The top cover spare part kit includes the TouchPad and TouchPad cable.

Description	Spare part number
In butter gold finish	641401-001
In charcoal gray finish	641404-001
In luminous rose finish	641403-001
In ocean drive finish	641402-001
In Pacific blue finish	641399-001
In pearl pink finish	641406-001
In pewter finish	641405-001
In Sonoma red finish	640193-001
In sweet purple finish	641400-001

Before removing the top cover, follow these steps:

1. Shut down the computer. If you are unsure whether the computer is off or in Hibernation, turn the computer on, and then shut it down through the operating system.
2. Disconnect all external devices connected to the computer.
3. Disconnect the power from the computer by first unplugging the power cord from the AC outlet and then unplugging the AC adapter from the computer.
4. Remove the battery (see [Battery on page 47](#)), and then remove the following components:
  - Optical drive (see [Optical drive on page 49](#))
  - Hard drive (see [Hard drive on page 51](#))
  - Keyboard (see [Keyboard on page 57](#))

When replacing the top cover, be sure that the following components are removed from the defective top cover and installed on the replacement top cover:

- Power button board and cable (see [Power button board on page 64](#))
- TouchPad button board and cable (see [TouchPad button board on page 66](#))
- TouchPad LED board and cable (see [TouchPad LED board on page 67](#))

Remove the top cover:

1. Close the computer.
2. Turn the computer upside down, with the front toward you.

3. Remove the 12 Phillips PM2.5×7.0 screws that secure the top cover to the computer.

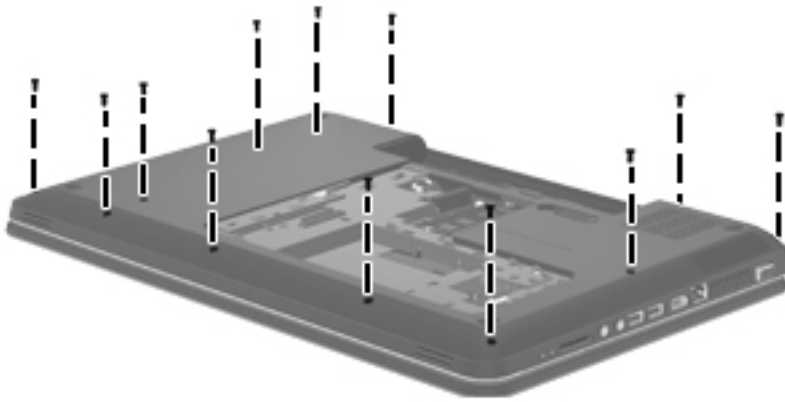

4. Remove the two Phillips PM2.5×7.0 screws **(1)** in the hard drive bay and the three Phillips PM2.5×6.0 screws **(2)** in the battery bay that secure the top cover to the computer.

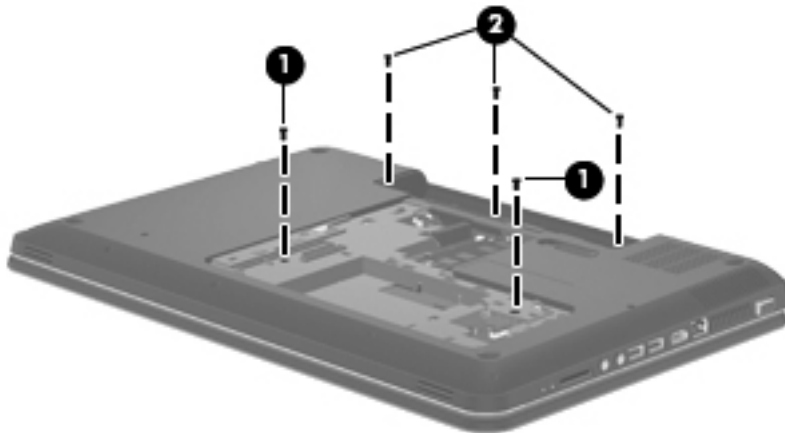

5. Turn the computer right-side up, with the front toward you.
6. Open the computer.
7. Release the ZIF connectors to which the following cables are attached, and then disconnect the cables from the system board:
  - Power button board cable **(1)** (included with the power button board spare part kit, spare part number 640212-001)
  - TouchPad cable **(2)** (included in the Cable Kit, spare part number 640206-001)
  - TouchPad button board cable **(3)** (included with the TouchPad button board spare part kit, spare part number 640214-001)

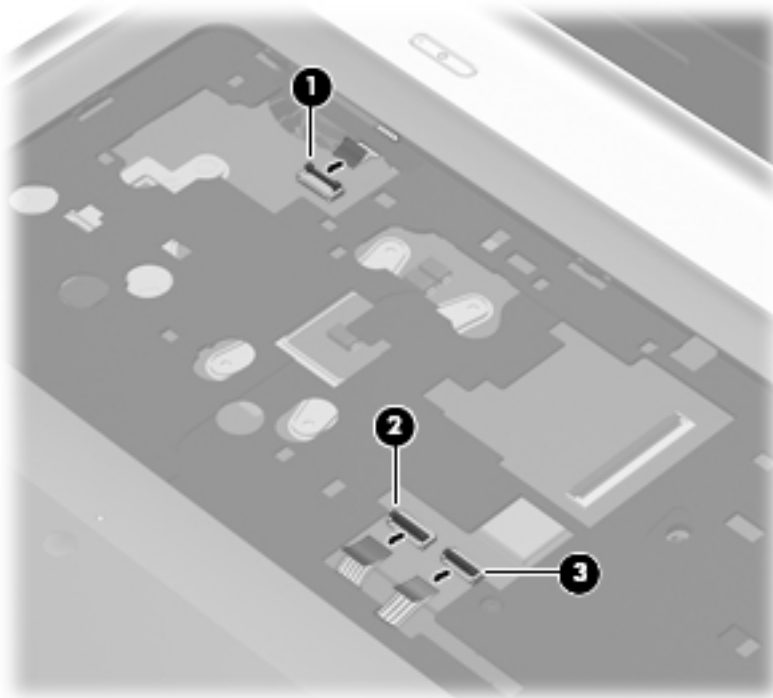

8. Remove the Phillips PM2.5×6.0 screw **(1)** that secures the top cover to the computer.
9. Lift the rear edge of the top cover **(2)** until the left and right sides disengage from the base enclosure.
10. Remove the top cover **(3)**.

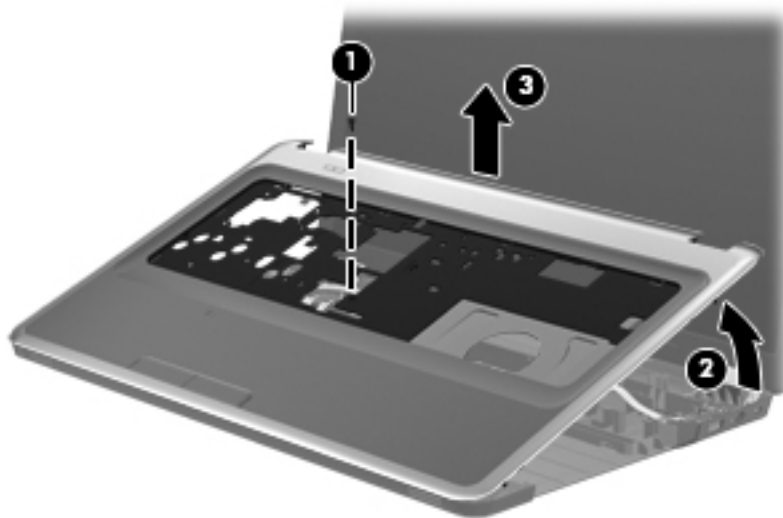

Reverse this procedure to install the top cover.

## Power button board

Description	Spare part number
Power button board (includes cable)	640212-001

Before removing the power button board, follow these steps:

1. Shut down the computer. If you are unsure whether the computer is off or in Hibernation, turn the computer on, and then shut it down through the operating system.
2. Disconnect all external devices connected to the computer.
3. Disconnect the power from the computer by first unplugging the power cord from the AC outlet and then unplugging the AC adapter from the computer.
4. Remove the battery (see [Battery on page 47](#)), and then remove the following components:
  - Optical drive (see [Optical drive on page 49](#))
  - Hard drive (see [Hard drive on page 51](#))
  - Keyboard (see [Keyboard on page 57](#))
  - Top cover (see [Top cover on page 61](#))

Remove the power button board:

1. Turn the top cover upside down, with the front toward you.
2. Release the power button board cable from the clip **(1)** built into the top cover.
3. Remove the Phillips PM2.0×4.0 screw **(2)** that secures the power button board to the top cover.
4. Lift the right side of the power button board **(3)** until it rests at an angle.



5. Remove the power button board and cable by sliding the board up and to the right at an angle (4).

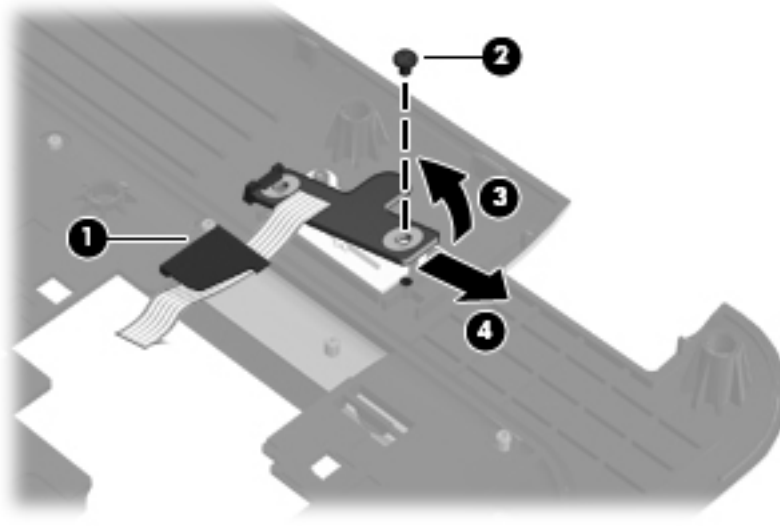

Reverse this procedure to install the power button board and cable.

## TouchPad button board

Description	Spare part number
TouchPad button board (includes cable)	640214-001

Before removing the TouchPad button board, follow these steps:

1. Shut down the computer. If you are unsure whether the computer is off or in Hibernation, turn the computer on, and then shut it down through the operating system.
2. Disconnect all external devices connected to the computer.
3. Disconnect the power from the computer by first unplugging the power cord from the AC outlet and then unplugging the AC adapter from the computer.
4. Remove the battery (see [Battery on page 47](#)), and then remove the following components:
  - Optical drive (see [Optical drive on page 49](#))
  - Hard drive (see [Hard drive on page 51](#))
  - Keyboard (see [Keyboard on page 57](#))
  - Top cover (see [Top cover on page 61](#))

Remove the TouchPad button board and cable:

1. Turn the top cover upside down, with the front toward you.
2. Release the TouchPad board cable **(1)** and the TouchPad button board cable **(2)** from the clips **(3)** built into the top cover.
3. Release the ZIF connector to which the TouchPad LED board cable is connected, and then disconnect the TouchPad LED board cable **(4)** from the TouchPad button board.
4. Remove the Phillips PM2.0×4.0 screw **(5)** that secures the TouchPad button board to the top cover.

5. Lift the rear edge of the TouchPad button board (6) until it is released from the clips built into the top cover.

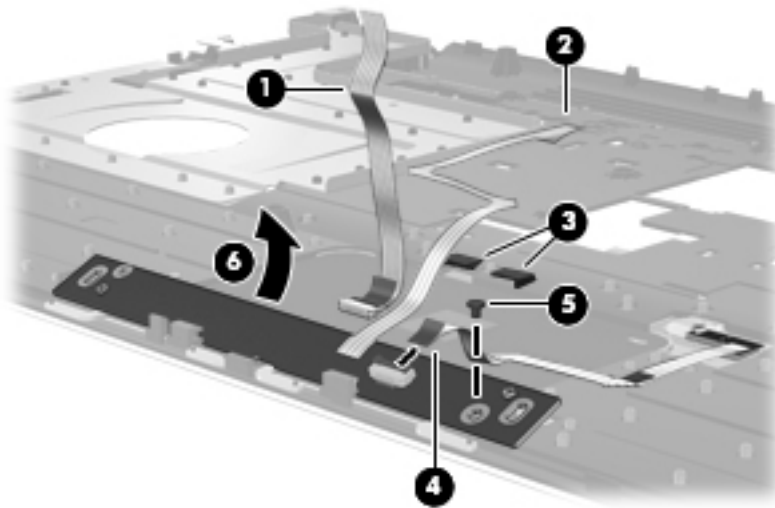

6. Remove the TouchPad button board and cable.

Reverse this procedure to install the TouchPad button board and cable.

## TouchPad LED board

Description	Spare part number
TouchPad LED board (includes cable)	640213-001

Before removing the TouchPad LED board, follow these steps:

1. Shut down the computer. If you are unsure whether the computer is off or in Hibernation, turn the computer on, and then shut it down through the operating system.
2. Disconnect all external devices connected to the computer.
3. Disconnect the power from the computer by first unplugging the power cord from the AC outlet and then unplugging the AC adapter from the computer.
4. Remove the battery (see [Battery on page 47](#)), and then remove the following components:
  - Optical drive (see [Optical drive on page 49](#))
  - Hard drive (see [Hard drive on page 51](#))
  - Keyboard (see [Keyboard on page 57](#))
  - Top cover (see [Top cover on page 61](#))

Remove the TouchPad LED board and cable:

1. Turn the top cover upside down, with the front toward you.
2. Release the ZIF connector **(1)** to which the TouchPad LED board cable is connected, and then disconnect the TouchPad LED board cable **(2)** from the TouchPad button board.
3. Release the TouchPad LED board cable from the clip **(3)** built into the top cover.
4. Detach the TouchPad LED board **(4)** from the top cover. (The TouchPad LED board is attached to the top cover with double-sided tape.)

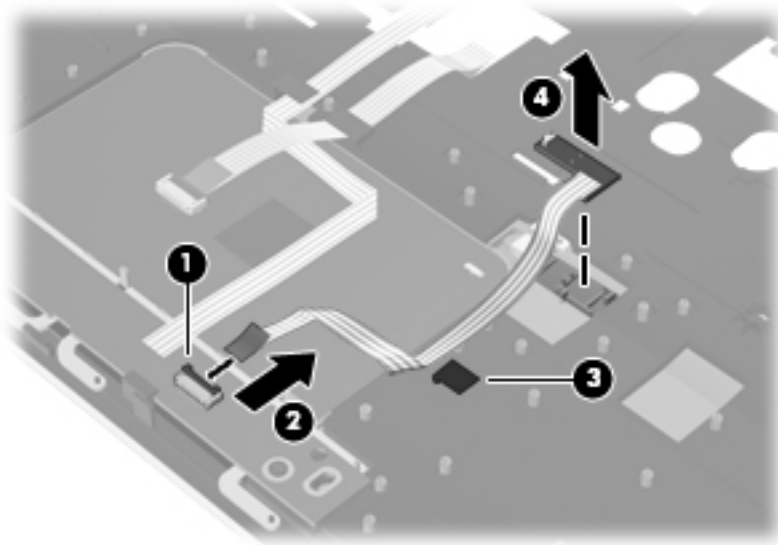

5. Remove the TouchPad LED board and cable.

Reverse this procedure to install the TouchPad LED board and cable.

## Bluetooth module



**NOTE:** This section applies only to computer models equipped with an Intel processor.

Description	Spare part number
Bluetooth module	537921-001

**NOTE:** The Bluetooth module spare part kit does not include a Bluetooth module cable. The Bluetooth module cable is available using spare part number 602538-001.

Before removing the Bluetooth module and cable, follow these steps:

1. Shut down the computer. If you are unsure whether the computer is off or in Hibernation, turn the computer on, and then shut it down through the operating system.
2. Disconnect all external devices connected to the computer.
3. Disconnect the power from the computer by first unplugging the power cord from the AC outlet and then unplugging the AC adapter from the computer.
4. Remove the battery (see [Battery on page 47](#)), and then remove the following components:
  - Optical drive (see [Optical drive on page 49](#))
  - Hard drive (see [Hard drive on page 51](#))
  - Keyboard (see [Keyboard on page 57](#))
  - Top cover (see [Top cover on page 61](#))

Remove the Bluetooth module and cable:

1. Disconnect the Bluetooth module cable **(1)** from the system board.

2. Release the clips **(2)** built into the base enclosure that secure the Bluetooth module, and then remove the module **(3)** from the clips.

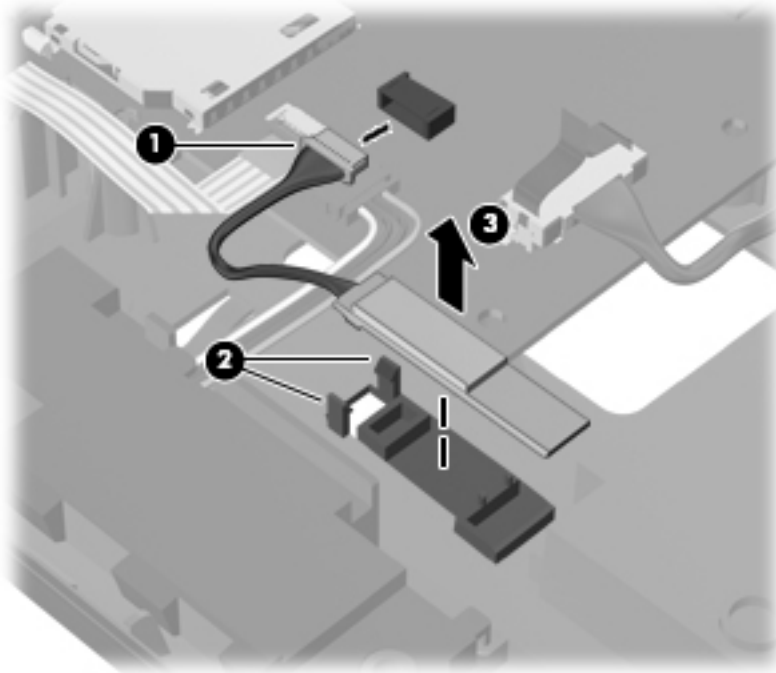

3. If it is necessary to replace the Bluetooth module cable, disconnect the cable from the Bluetooth module and replace it.

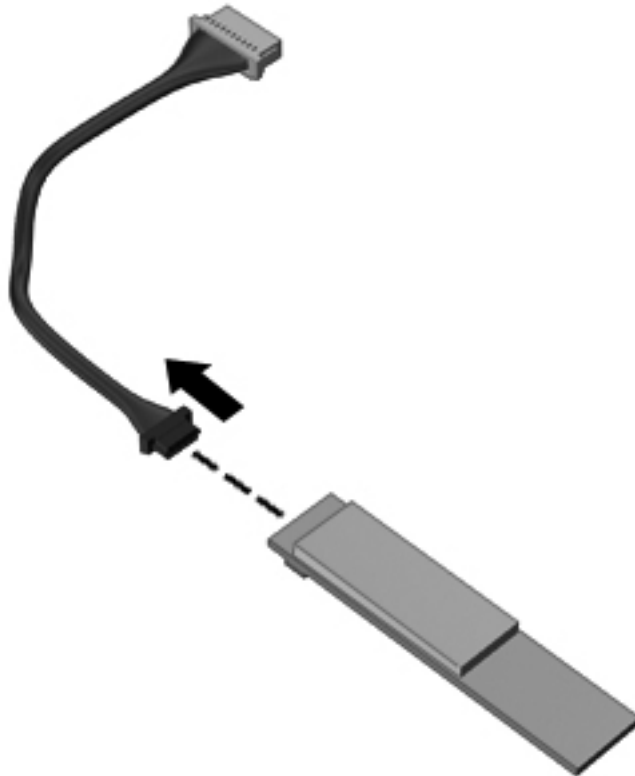

Reverse this procedure to install the Bluetooth module and cable.

## Speakers

Description	Spare part number
Speaker Kit (includes left and right speakers and cable)	641396-001

Before removing the speakers, follow these steps:

1. Shut down the computer. If you are unsure whether the computer is off or in Hibernation, turn the computer on, and then shut it down through the operating system.
2. Disconnect all external devices connected to the computer.
3. Disconnect the power from the computer by first unplugging the power cord from the AC outlet and then unplugging the AC adapter from the computer.
4. Remove the battery (see [Battery on page 47](#)), and then remove the following components:
  - Optical drive (see [Optical drive on page 49](#))
  - Hard drive (see [Hard drive on page 51](#))
  - Keyboard (see [Keyboard on page 57](#))
  - Top cover (see [Top cover on page 61](#))

Remove the TouchPad LED board and cable:

1. Disconnect the speaker cable **(1)** from the system board.
2. Remove the speakers **(2)**.

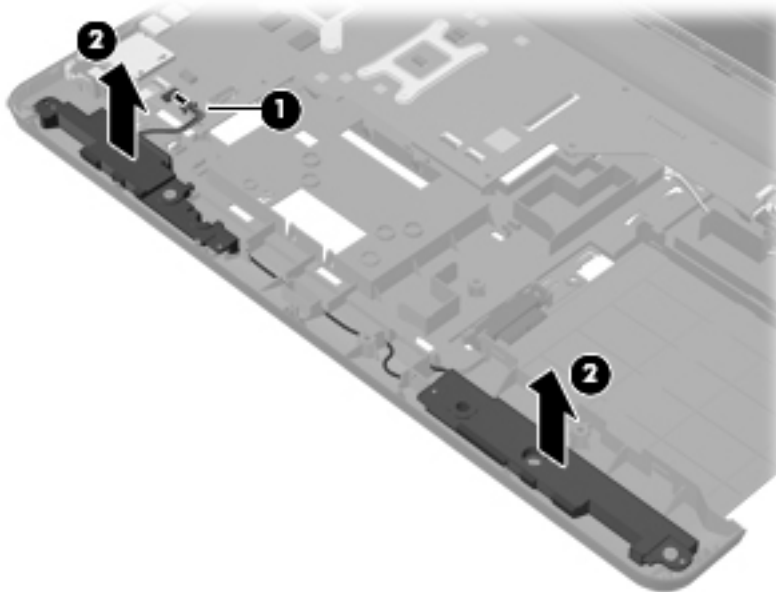

Reverse this procedure to install the speakers.

## LED board

Description	Spare part number
LED board	640215-001

Before removing the LED board, follow these steps:

1. Shut down the computer. If you are unsure whether the computer is off or in Hibernation, turn the computer on, and then shut it down through the operating system.
2. Disconnect all external devices connected to the computer.
3. Disconnect the power from the computer by first unplugging the power cord from the AC outlet and then unplugging the AC adapter from the computer.
4. Remove the battery (see [Battery on page 47](#)), and then remove the following components:
  - Optical drive (see [Optical drive on page 49](#))
  - Hard drive (see [Hard drive on page 51](#))
  - Keyboard (see [Keyboard on page 57](#))
  - Top cover (see [Top cover on page 61](#))

Remove the LED board:

1. Release the ZIF connector **(1)** to which the LED board cable is connected, and then disconnect the LED board cable **(2)** from the system board.
2. Release the clips **(3)** built into the base enclosure that secure the LED board.
3. Lift the right edge of the LED board **(4)** to release it from clips built into the base enclosure.



4. Remove the LED board and cable by sliding the board **(5)** up and to the right at an angle.

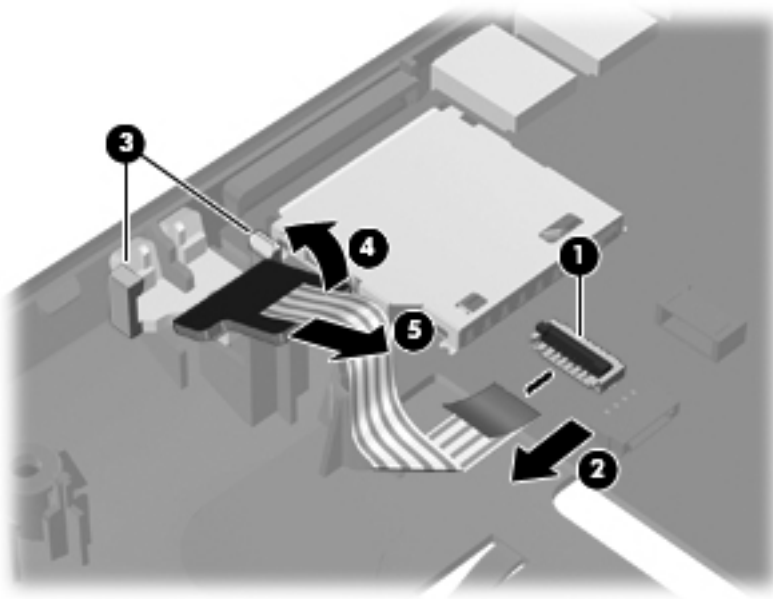

Reverse this procedure to install the LED board and cable.

## USB board

Description	Spare part number
USB board (includes cable)	640211-001

Before removing the USB board, follow these steps:

1. Shut down the computer. If you are unsure whether the computer is off or in Hibernation, turn the computer on, and then shut it down through the operating system.
2. Disconnect all external devices connected to the computer.
3. Disconnect the power from the computer by first unplugging the power cord from the AC outlet and then unplugging the AC adapter from the computer.
4. Remove the battery (see [Battery on page 47](#)), and then remove the following components:
  - Optical drive (see [Optical drive on page 49](#))
  - Hard drive (see [Hard drive on page 51](#))
  - Keyboard (see [Keyboard on page 57](#))
  - Top cover (see [Top cover on page 61](#))

Remove the USB board:

1. Release the ZIF connector **(1)** to which the USB board cable is connected, and then disconnect the USB board cable **(2)** from the system board.
2. Release the clip **(3)** built into the base enclosure that secures the USB board to the base enclosure.

3. Remove the USB board **(4)** and cable.

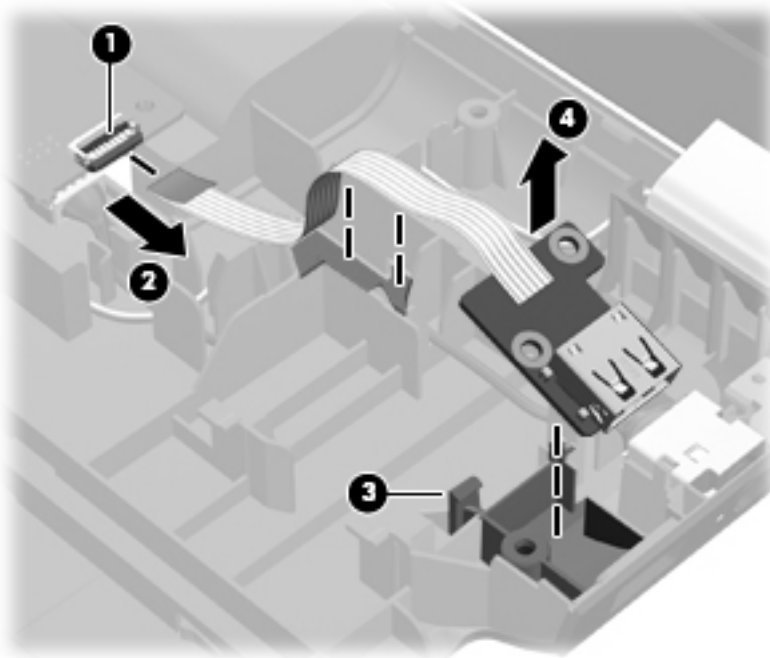

Reverse this procedure to install the USB board.

## Power connector cable

Description	Spare part number
Power connector cable	641394-001

Before removing the power connector cable, follow these steps:

1. Shut down the computer. If you are unsure whether the computer is off or in Hibernation, turn the computer on, and then shut it down through the operating system.
2. Disconnect all external devices connected to the computer.
3. Disconnect the power from the computer by first unplugging the power cord from the AC outlet and then unplugging the AC adapter from the computer.
4. Remove the battery (see [Battery on page 47](#)), and then remove the following components:
  - Optical drive (see [Optical drive on page 49](#))
  - Hard drive (see [Hard drive on page 51](#))
  - Keyboard (see [Keyboard on page 57](#))
  - Top cover (see [Top cover on page 61](#))
  - USB board (see [USB board on page 74](#))

Remove the power connector cable:

1. Disconnect the power connector cable **(1)** from the system board.
2. Release the power connector cable **(2)** from the clips **(3)** built into the base enclosure.
3. Remove the power connector **(4)** from the clip **(5)** built into the base enclosure.

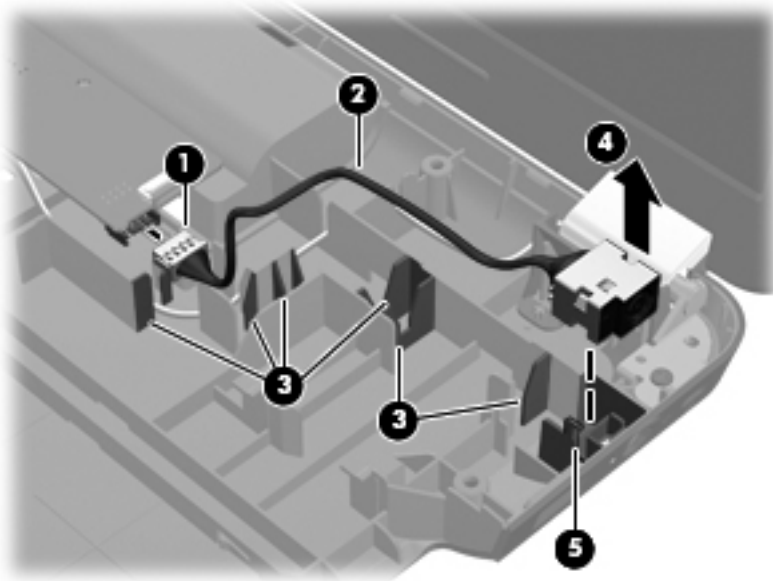

Reverse this procedure to install the power connector cable.

## System board

 **NOTE:** The system board spare part kit includes replacement thermal material. Replacement thermal material is also available in the Thermal Material Kit, spare part number 634433-001.

Description	Spare part number
For use only with computer models equipped with an AMD processor:	
Equipped with an AMD Fusion E-450 1.65-GHz processor (dual core, 18 W) and a graphics subsystem with UMA video memory	660773-001
For use only with computer models equipped with the AMD A60M chipset and a graphics subsystem with 1024-MB of discrete video memory	649950-001
For use only with computer models equipped with the AMD A60M chipset and a graphics subsystem with 512-MB of discrete video memory	649949-001
For use only with computer models equipped with the AMD A60M chipset and a graphics subsystem with UMA video memory	649948-001
For use only with computer models equipped with the AMD RS880MD chipset and a graphics subsystem with 1024-MB of discrete video memory	647627-001
For use only with computer models equipped with the AMD RS880MD chipset and a graphics subsystem with 512-MB of discrete video memory	647626-001
For use only with computer models equipped with an AMD Athlon, Phenom, Turion, or V-series processor and a graphics subsystem with 1024-MB of discrete video memory	638855-001
For use only with computer models equipped with an AMD Athlon, Phenom, Turion, or V-series processor and a graphics subsystem with 512-MB of discrete video memory	638854-001
For use only with computer models equipped with an AMD Athlon, Phenom, Turion, or V-series processor and a graphics subsystem with UMA video memory	638856-001
For use only with computer models equipped with an Intel processor:	
For use only with computer models equipped with the Intel HM65 chipset and a graphics subsystem with 1024-MB of discrete video memory and supports bus alive/chip off (BACO)	650199-001
For use only with computer models equipped with the Intel HM65 chipset and a graphics subsystem with 512-MB of discrete video memory and supports bus alive/chip off (BACO)	650198-001
For use only with computer models equipped with the HM65 chipset and a graphics subsystem with 1024-MB of discrete video memory	636375-001
For use only with computer models equipped with the HM65 chipset and a graphics subsystem with 512-MB of discrete video memory	636374-001
For use only with computer models equipped with an HM65 chipset and a graphics subsystem with UMA video memory	636373-001
For use only with computer models equipped with the HM55 chipset and a graphics subsystem with 1024-MB of discrete video memory	636372-001
For use only with computer models equipped with the HM55 chipset and a graphics subsystem with 512-MB of discrete video memory	636371-001
For use only with computer models equipped with the HM55 chipset and a graphics subsystem with UMA video memory	636370-001

Description	Spare part number
Equipped with an Intel Core i3-370M 2.40-GHz processor (3.0-MB L3 cache, dual core, 35 W), the HM55 chipset, and a graphics subsystem with 1024-MB of discrete video memory	654117-001
Equipped with an Intel Core i3-370M 2.40-GHz processor (3.0-MB L3 cache, dual core, 35 W), the HM55 chipset, and a graphics subsystem with UMA video memory	654118-001

Before removing the system board, follow these steps:

1. Shut down the computer. If you are unsure whether the computer is off or in Hibernation, turn the computer on, and then shut it down through the operating system.
2. Disconnect all external devices connected to the computer.
3. Disconnect the power from the computer by first unplugging the power cord from the AC outlet and then unplugging the AC adapter from the computer.
4. Remove the battery (see [Battery on page 47](#)), and then remove the following components:
  - Optical drive (see [Optical drive on page 49](#))
  - Hard drive (see [Hard drive on page 51](#))
  - RTC battery (see [RTC battery on page 53](#))
  - WLAN module (see [WLAN module on page 55](#))
  - Keyboard (see [Keyboard on page 57](#))
  - Top cover (see [Top cover on page 61](#))

When replacing the system board, be sure that the following components are removed from the defective system board and installed on the replacement system board:

- Memory module (see [Memory module on page 54](#))
- Fan and heat sink (see [Fan and heat sink on page 83](#))
- Processor (see [Processor on page 90](#))

Remove the system board:

1. Disconnect the following cables from the system board:
  - LED board cable **(1)**
  - Speaker cable **(2)**
  - Optical drive cable **(3)**
  - Display panel cable **(4)**

2. Remove the Phillips PM2.5x7.0 screw **(5)** that secures the system board to the base enclosure.

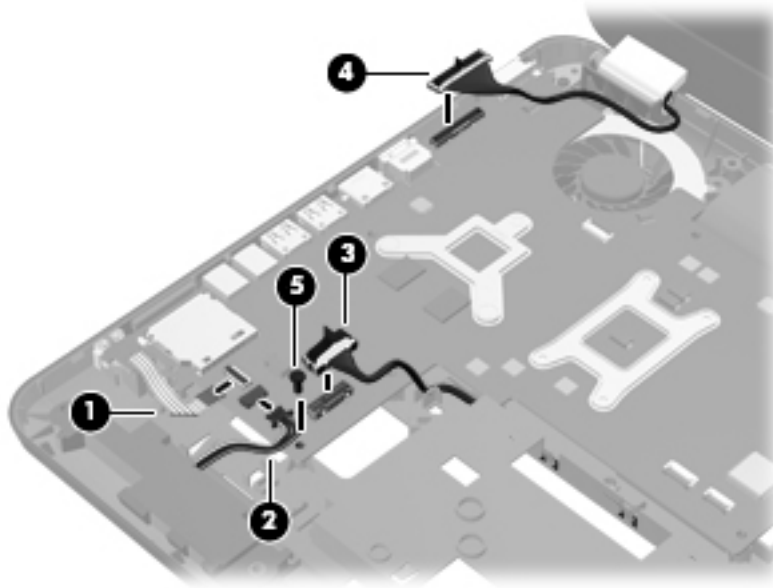

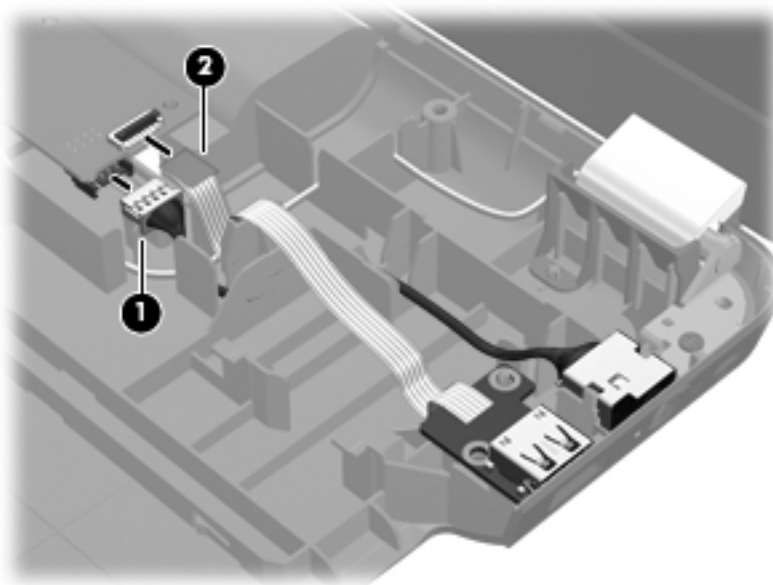

3. Disconnect the power connector cable **(1)** from the system board.
4. Release the ZIF connector to which the USB board cable is attached, and then disconnect the USB cable **(2)** from the system board.

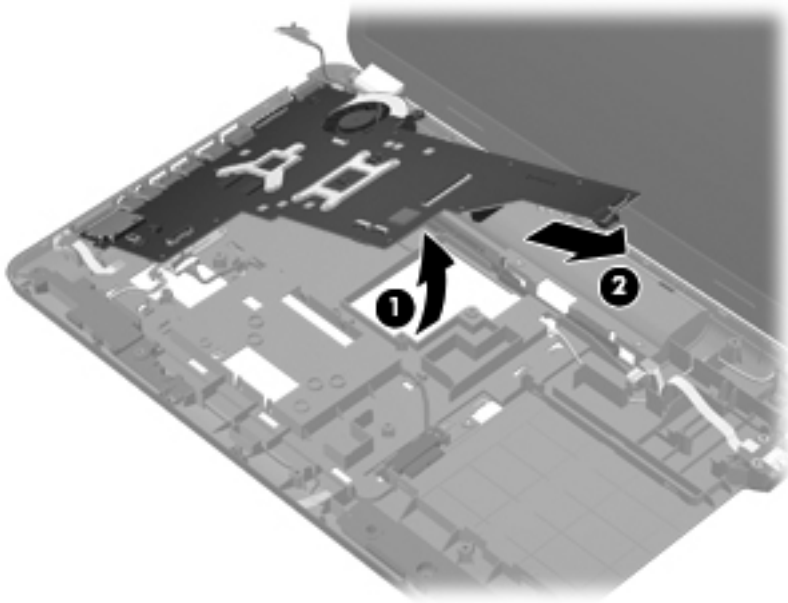

5. Lift the right side of the system board **(1)** until it rests at an angle.

6. Remove the system board (2) by sliding it up and to the right at an angle.



 **NOTE:** System boards for use with computer models equipped with an AMD processor have the Southbridge chip located on the bottom of the board. A thermal pad is used on the Southbridge chip (1) and the base enclosure heat sink (2) that services it. The thermal material must be thoroughly cleaned from the surfaces of the system board and the heat sink attached to the base enclosure each time the system board is removed. Replacement thermal material is included with all base enclosure and system board spare part kits.

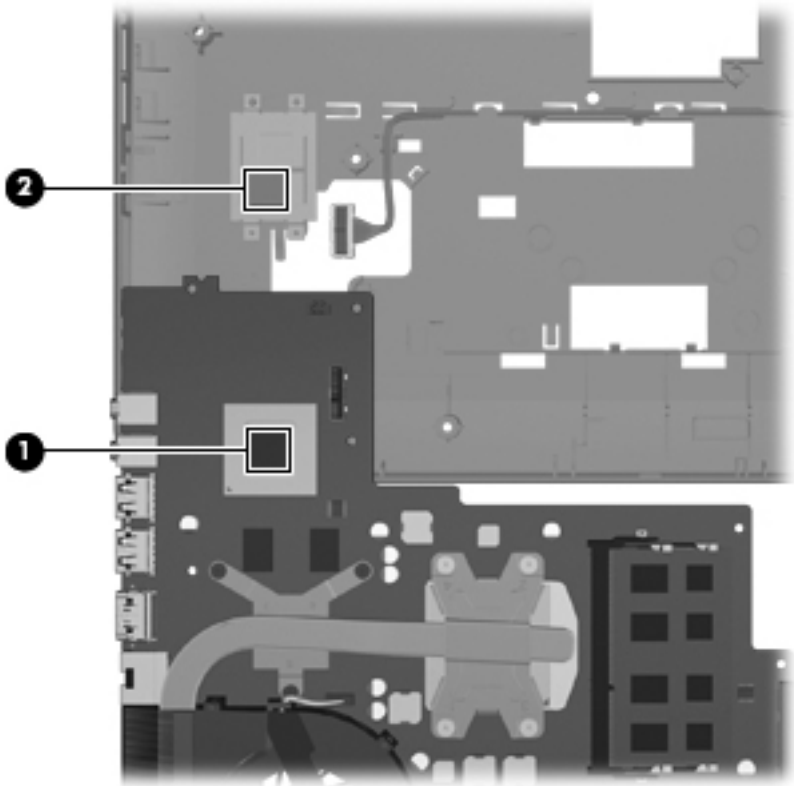



Reverse this procedure to install the system board.

## Optical drive cable

---

 **NOTE:** The optical drive cable is included in the Cable Kit, spare part number 640206-001. The optical drive cable includes the optical drive connector.

---

Before removing the optical drive cable, follow these steps:

1. Shut down the computer. If you are unsure whether the computer is off or in Hibernation, turn the computer on, and then shut it down through the operating system.
2. Disconnect all external devices connected to the computer.
3. Disconnect the power from the computer by first unplugging the power cord from the AC outlet and then unplugging the AC adapter from the computer.
4. Remove the battery (see [Battery on page 47](#)), and then remove the following components:
  - Optical drive (see [Optical drive on page 49](#))
  - Hard drive (see [Hard drive on page 51](#))
  - Keyboard (see [Keyboard on page 57](#))
  - Top cover (see [Top cover on page 61](#))
  - System board (see [System board on page 77](#))

Remove the optical drive cable:

1. Release the optical drive cable **(1)** from the clips **(2)** built into the base enclosure.

2. Release the clips **(3)** built into the base enclosure that secure the optical drive connector, and then release the connector **(4)** from the clips.

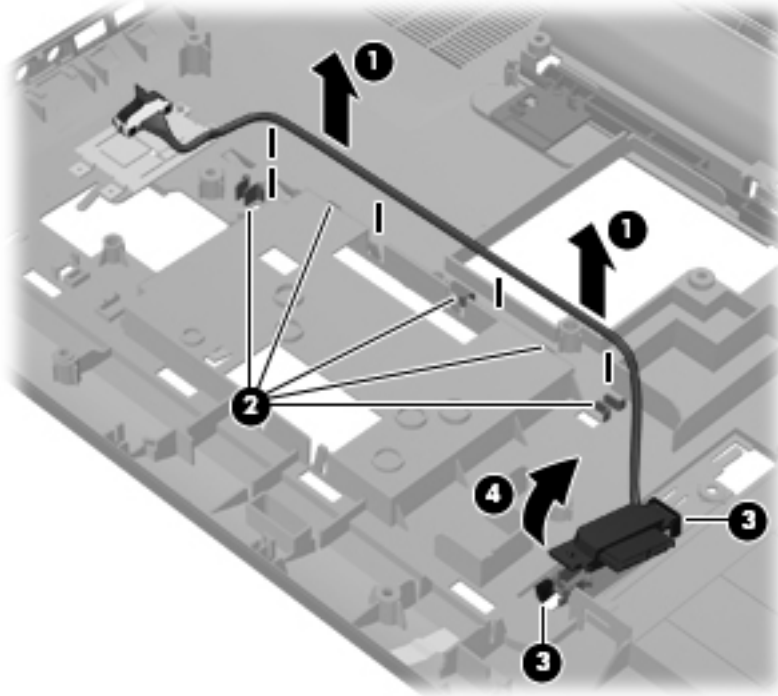

3. Remove the optical drive connector and cable.

Reverse this procedure to install the optical drive connector and cable.

## Fan and heat sink

 **NOTE:** The fan and heat sink spare part kits include replacement thermal material. Replacement thermal material is also available in the Thermal Material Kit, spare part number 634433-001.

Description	Spare part number
Fan	639460-001
Heat sink:	
For use only with computer models equipped with an AMD processor:	
For use only with computer models equipped with the AMD A60M chipset and a graphics subsystem with discrete video memory	649953-001
For use only with computer models equipped with the AMD A60M chipset and a graphics subsystem with UMA video memory	649954-001
For use only with computer models equipped with the AMD RS880MD chipset and a graphics subsystem with discrete video memory	649952-001
For use only with computer models equipped with an AMD Athlon, Phenom, Turion, or V-series processor and a graphics subsystem with discrete video memory	639462-001
For use only with computer models equipped with an AMD Athlon, Phenom, Turion, or V-series processor and a graphics subsystem with UMA video memory	639463-001
For use only with computer models equipped with an Intel processor:	
For use only with computer models equipped with the Intel HM65 or HM55 chipset and a graphics subsystem with discrete video memory and supports bus alive/chip off (BACO)	654119-001
For use only with computer models equipped with the Intel HM65 or HM55 chipset and a graphics subsystem with UMA video memory and supports bus alive/chip off (BACO)	654120-001
For use only with computer models equipped with the HM65 chipset and a graphics subsystem with discrete video memory	641141-001
For use only with computer models equipped with the HM65 chipset and a graphics subsystem with UMA video memory	641140-001
For use only with computer models equipped with the HM55 chipset and a graphics subsystem with discrete video memory	637190-001
For use only with computer models equipped with the HM55 chipset and a graphics subsystem with UMA video memory	637189-001

 **NOTE:** To properly ventilate the computer, allow at least 7.6 cm (3 in) of clearance on the left side of the computer. The computer uses an electric fan for ventilation. The fan is controlled by a temperature sensor and is designed to turn on automatically when high temperature conditions exist. These conditions are affected by high external temperatures, system power consumption, power management/battery conservation configurations, battery fast charging, and software requirements. Exhaust air is displaced through the ventilation grill located on the left side of the computer.

Before removing the fan and heat sink, follow these steps:

1. Shut down the computer. If you are unsure whether the computer is off or in Hibernation, turn the computer on, and then shut it down through the operating system.
2. Disconnect all external devices connected to the computer.
3. Disconnect the power from the computer by first unplugging the power cord from the AC outlet and then unplugging the AC adapter from the computer.
4. Remove the battery (see [Battery on page 47](#)), and then remove the following components:
  - Optical drive (see [Optical drive on page 49](#))
  - Hard drive (see [Hard drive on page 51](#))
  - WLAN module (see [WLAN module on page 55](#))
  - Keyboard (see [Keyboard on page 57](#))
  - Top cover (see [Top cover on page 61](#))
  - System board (see [System board on page 77](#))

Remove the fan and heat sink:

1. Turn the system board upside down, with the fan toward you.



---

**NOTE:** Steps 2 through 5 apply only to computer models equipped with a graphics subsystem with discrete memory. See steps 6 through 8 for fan and heat sink removal information for computer models equipped with a graphics subsystem with UMA memory.

---

2. Disconnect the fan cable **(1)** from the system board.
3. Loosen the captive screws **(2)** that secure the fan and heat sink to the system board. (Computer models equipped with an AMD processor have three captive screws. Computer models equipped with an Intel processor have four captive screws.)
4. Remove the three Phillips PM2.5×6.0 screws **(3)** that secure the fan and heat sink to the system board.



---

**NOTE:** Due to the adhesive quality of the thermal material located between the heat sink and system board components, it may be necessary to move the heat sink from side to side to detach it.

---

5. Remove the fan and heat sink (4).

 **NOTE:** The following illustration shows the fan and heat sink being removed from a computer model equipped with an AMD processor and a graphics subsystem with discrete memory.

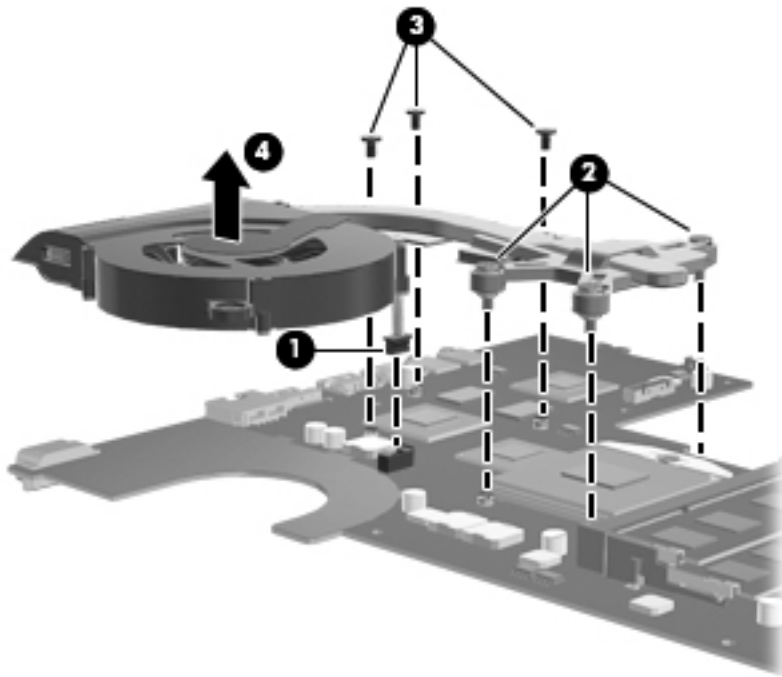

 **NOTE:** The following illustration shows the fan and heat sink being removed from a computer model equipped with an Intel processor and a graphics subsystem with discrete memory.

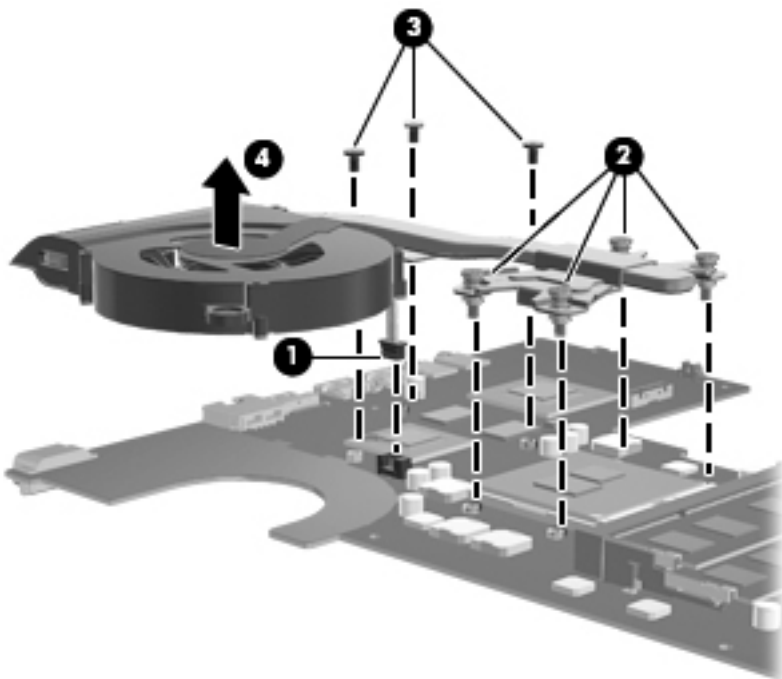

 **NOTE:** Steps 6 through 8 apply only to computer models equipped with a graphics subsystem with UMA memory. See steps 2 through 5 for fan and heat sink removal information for computer models equipped with a graphics subsystem with discrete memory.

6. Disconnect the fan cable **(1)** from the system board.
7. Loosen the captive screws **(2)** that secure the fan and heat sink to the system board. (Computer models equipped with an AMD processor have three captive screws. Computer models equipped with an Intel processor have four captive screws.)

 **NOTE:** Due to the adhesive quality of the thermal material located between the heat sink and system board components, it may be necessary to move the heat sink from side to side to detach it.

8. Remove the fan and heat sink **(3)**.

 **NOTE:** The following illustration shows the fan and heat sink removal process on a computer model equipped with an AMD processor and a graphics subsystem with UMA memory.

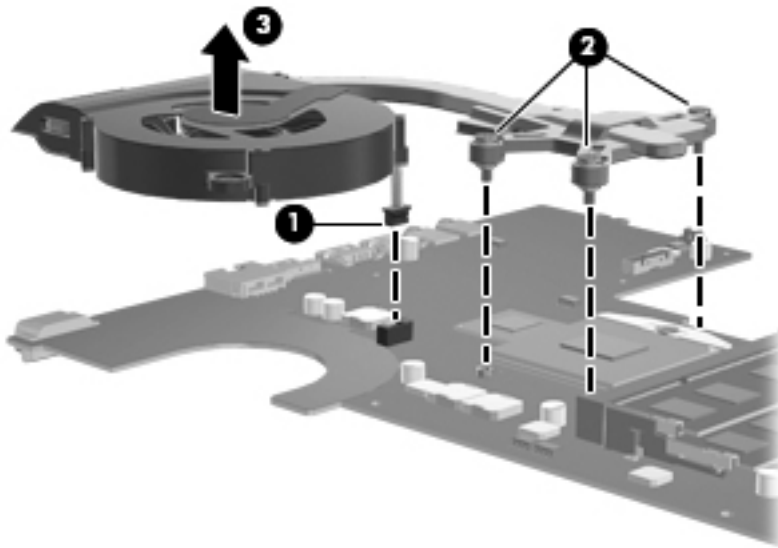

 **NOTE:** The following illustration shows the fan and heat sink removal process on a computer model equipped with an Intel processor and a graphics subsystem with UMA memory.

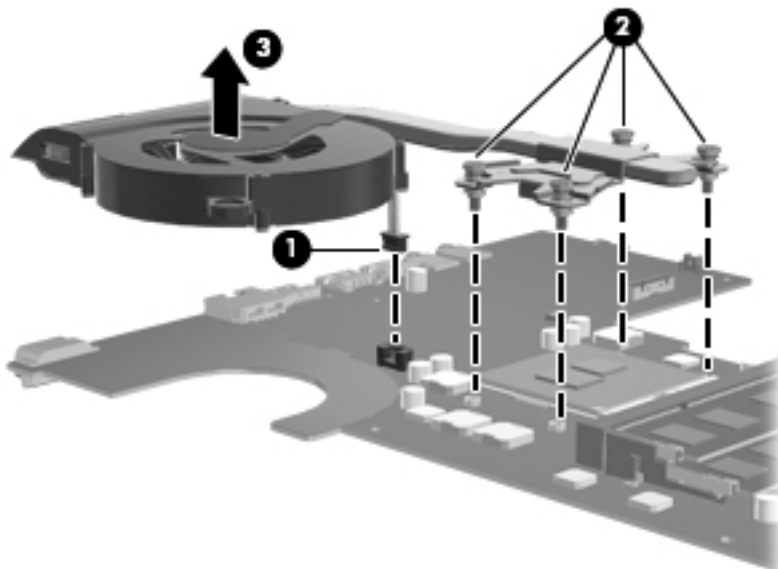

 **NOTE:** The thermal material must be thoroughly cleaned from the surfaces of the heat sink and the system board components each time the heat sink is removed. Replacement thermal material is included with the base enclosure, fan, heat sink, processor, and system board spare part kits. Replacement thermal material is also available in the Thermal Material Kit, spare part number 634433-001.

 **NOTE:** The following illustration shows the replacement thermal material locations on a computer model equipped with an AMD processor and a graphics subsystem with discrete memory.

- Thermal paste is used on the processor **(1)** and the heat sink section **(2)** that services it
- A thermal pad is used on the Northbridge chip **(3)** and the heat sink section **(4)** that services it
- A thermal pad is used on the graphics subsystem chip **(5)** and the heat sink section **(6)** that services it

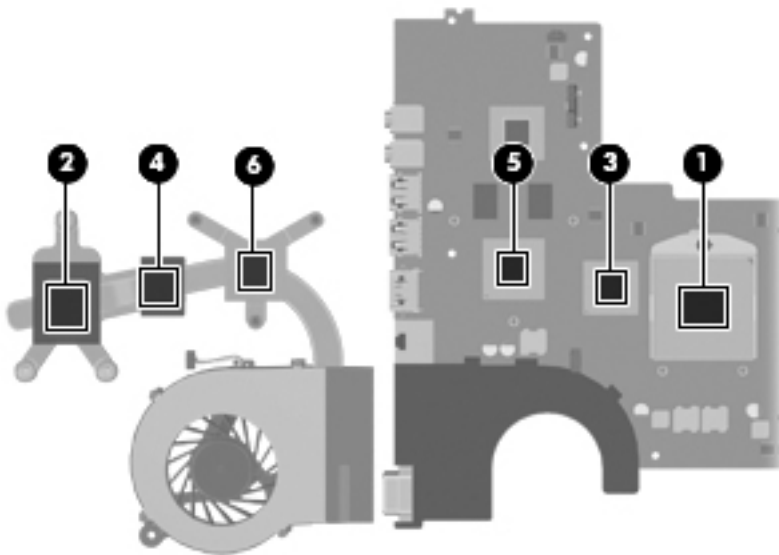

 **NOTE:** The following illustration shows the replacement thermal material locations on a computer model equipped with an AMD processor and a graphics subsystem with UMA memory.

- Thermal paste is used on the processor **(1)** and the heat sink section **(2)** that services it
- A thermal pad is used on the Northbridge chip **(3)** and the heat sink section **(4)** that services it

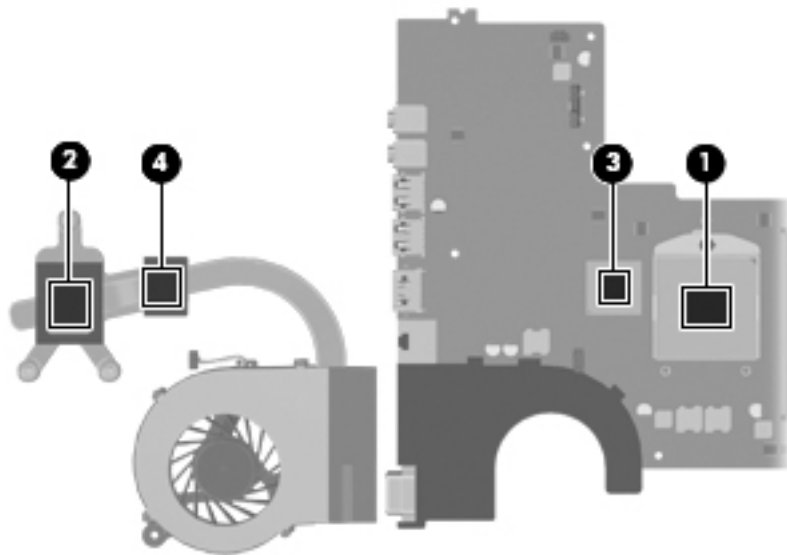

**NOTE:** The following illustration shows the replacement thermal material locations on a computer model equipped with an Intel processor and a graphics subsystem with discrete memory.

- Thermal paste is used on the processor **(1)** and Northbridge chip and the heat sink section **(2)** that services them
- A thermal pad is used on the graphics subsystem chip **(3)** and the heat sink section **(4)** that services it

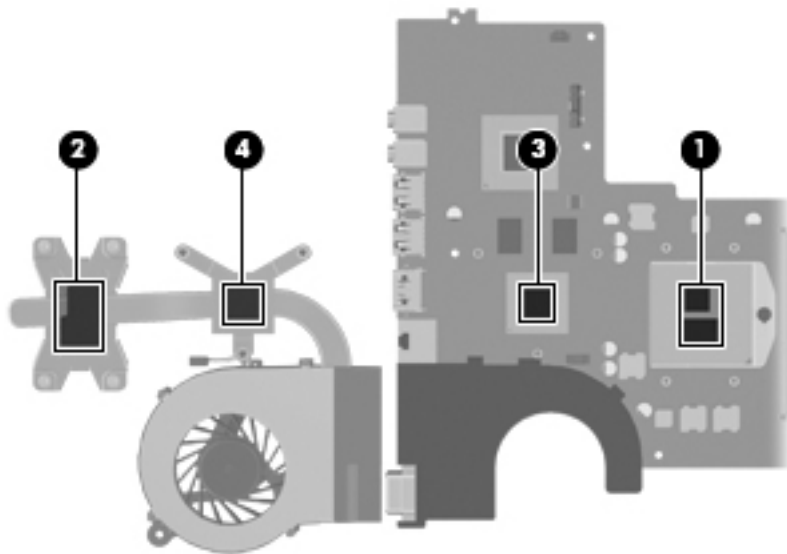

**NOTE:** The following illustration shows the replacement thermal material locations on a computer model equipped with an Intel processor and a graphics subsystem with UMA memory. Thermal paste is used on the processor **(1)** and Northbridge chip and the heat sink section **(2)** that services them.



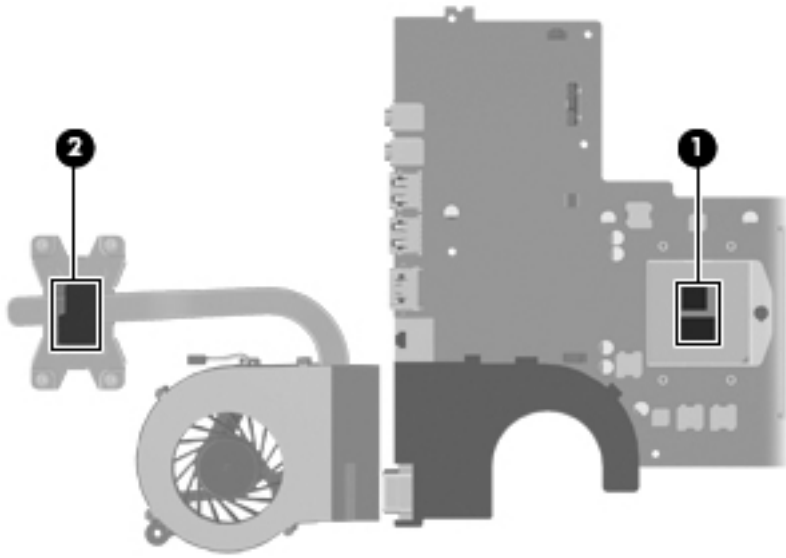

9. If it is necessary to replace the fan:
  - a. Remove the two Phillips PM2.0×3.0 screws **(1)** that secure the fan to the heat sink.
  - b. Release the two clips **(2)** that secure the fan to the heat sink.
  - c. Remove the fan **(3)** from the heat sink.

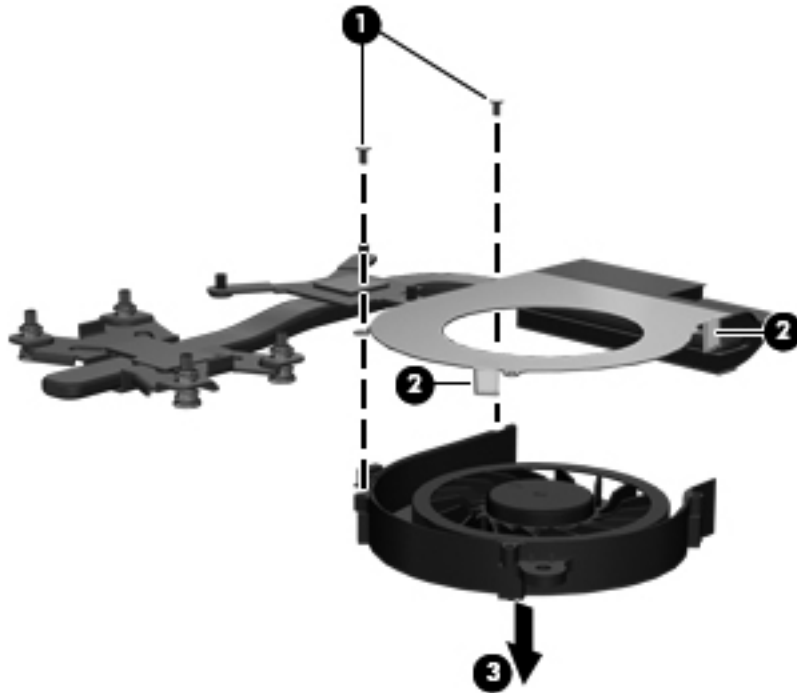

Reverse this procedure to reassemble and install the fan and heat sink.

## Processor



**NOTE:** The processor spare part kit includes replacement thermal material. Replacement thermal material is also available in the Thermal Material Kit, spare part number 634433-001.

Description	Spare part number
AMD A8-3500M 2.40-GHz processor (1.5-GHz FSB, 4.0-MB L2 cache, quad core, 35 W)	653350-001
AMD A6-3400M 2.30-GHz processor (1.4-GHz FSB, 4.0-MB L2 cache, quad core, 35 W)	653349-001
AMD A4-3300M 2.50-GHz processor (1.9-GHz FSB, 4.0-MB L2 cache, dual core, 35 W)	653348-001
AMD Athlon II P360 2.30-GHz processor (1.0-MB L2 cache, 1066-MHz, 3.2GT/sec, dual core, 25 W)	636635-001
AMD Athlon II P340 2.20-GHz processor (1.0-MB L2 cache, 1066-MHz, 3.2GT/sec, dual core, 25 W)	616343-001
AMD Phenom II N970 2.20-GHz processor (2.0-MB L2 cache, 1333-MHz, 3.6GT/sec, quad core, 35 W)	635496-001
AMD Phenom II N870 2.30-GHz processor (1.5-MB L2 cache, 1333-MHz, 3.6GT/sec, triple core, 35 W)	635495-001
AMD Phenom II N850 2.20-GHz processor (1.5-MB L2 cache, 1333-MHz, 3.6GT/sec, triple core, 35 W)	616345-001
AMD Phenom II N660 3.00-GHz processor (2.0-MB L2 cache, 1333-MHz, 3.6GT/sec, dual core, 35 W)	635494-001
AMD Phenom II P960 1.80-GHz processor (2.0-MB L2 cache, 1066-MHz, 3.6GT/sec, quad core, 25 W)	634689-001
AMD Phenom II P860 2.00-GHz processor (1.5-MB L2 cache, 1333-MHz, 3.6GT/sec, triple core, 25 W)	634688-001
AMD Phenom II P650 2.60-GHz processor (2.0-MB L2 cache, 1066-MHz, 3.6GT/sec, triple core, 25 W)	634687-001
AMD Turion II P560 2.50-GHz processor (2.0-MB L2 cache, 1066-MHz, 3.6GT/sec, dual core, 25 W)	634691-001
AMD V160 2.40-GHz processor (512-KB L2 cache, 1066-MHz 3.2-GT/sec, single core, 25 W)	616333-001
AMD V140 2.30-GHz processor (512-KB L2 cache, 1066-MHz 3.2-GT/sec, single core, 25 W)	636634-001
Intel Core i7-2620M 2.70-GHz (SC turbo up to 3.40-GHz) processor (4.0-MB L3 cache, dual core, 35 W)	631252-001
Intel Core i5-2540M 2.60-GHz (SC turbo up to 3.30-GHz) processor (3.0-MB L3 cache, dual core, 35 W)	631255-001
Intel Core i5-2520M 2.50-GHz (SC turbo up to 3.20-GHz) processor (3.0-MB L3 cache, dual core, 35 W)	631253-001
Intel Core i5-2430M 2.40-GHz (SC turbo up to 3.00-GHz) processor (3.0-MB L3 cache, dual core, 35 W)	653341-001
Intel Core i5-2410M 2.30-GHz (SC turbo up to 2.90-GHz) processor (3.0-MB L3 cache, dual core, 35 W)	638039-001

Description	Spare part number
Intel Core i5-480M 2.66-GHz (SC turbo up to 2.93-GHz) processor (3.0-MB L3 cache, dual core, 35 W)	634693-001
Intel Core i3-2350M 2.30-GHz processor (3.0-MB L3 cache, dual core, 35 W)	653340-001
Intel Core i3-2330M 2.20-GHz processor (3.0-MB L3 cache, dual core, 35 W)	653339-001
Intel Core i3-2310M 2.10-GHz processor (3.0-MB L3 cache, dual core, 35 W)	638037-001
Intel Core i3-390M 2.66-GHz processor (3.0-MB L3 cache, dual core, 35 W)	634692-001
Intel Core i3-380M 2.53-GHz processor (3.0-MB L3 cache, dual core, 35 W)	625823-001
Intel Pentium B950 TJ85 2.10-GHz processor (2.0-MB L3 cache, dual core 35 W)	653338-001
Intel Pentium B940 TJ85 2.00-GHz processor (2.0-MB L3 cache, dual core 35 W)	653337-001
Intel Pentium P6200 2.13-GHz processor (3.0-MB L3 cache, dual core, 35 W)	625831-001
Intel Pentium P6300 2.26-GHz processor (3.0-MB L3 cache, dual core, 35 W)	635500-001

Before removing the processor, follow these steps:

1. Shut down the computer. If you are unsure whether the computer is off or in Hibernation, turn the computer on, and then shut it down through the operating system.
2. Disconnect all external devices connected to the computer.
3. Disconnect the power from the computer by first unplugging the power cord from the AC outlet and then unplugging the AC adapter from the computer.
4. Remove the battery (see [Battery on page 47](#)), and then remove the following components:
  - Optical drive (see [Optical drive on page 49](#))
  - Hard drive (see [Hard drive on page 51](#))
  - WLAN module (see [WLAN module on page 55](#))
  - Keyboard (see [Keyboard on page 57](#))
  - Top cover (see [Top cover on page 61](#))
  - System board (see [System board on page 77](#))
  - Fan and heat sink (see [Fan and heat sink on page 83](#))

Remove the processor:

1. Use a flat-bladed screw driver **(1)** to turn the processor locking screw one-half turn counterclockwise **(2)**, until you hear a click.

2. Lift the processor **(3)** straight up, and remove it.

 **NOTE:** The gold triangle **(4)** on the processor must be aligned with the triangle icon embossed on the processor socket when you install the processor.

 **NOTE:** The following illustration shows the processor removal process on a computer model equipped with an AMD processor.

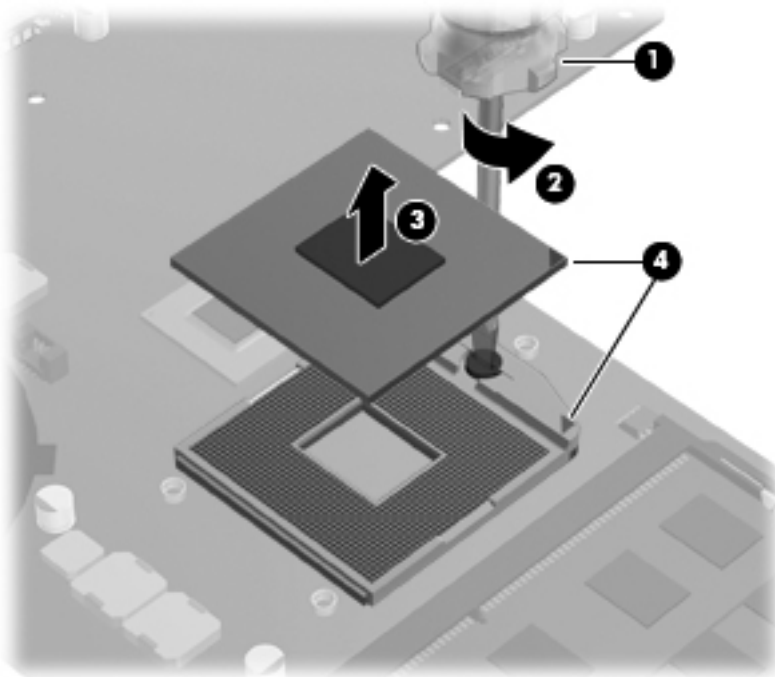

 **NOTE:** The following illustration shows the processor removal process on a computer model equipped with an Intel processor.

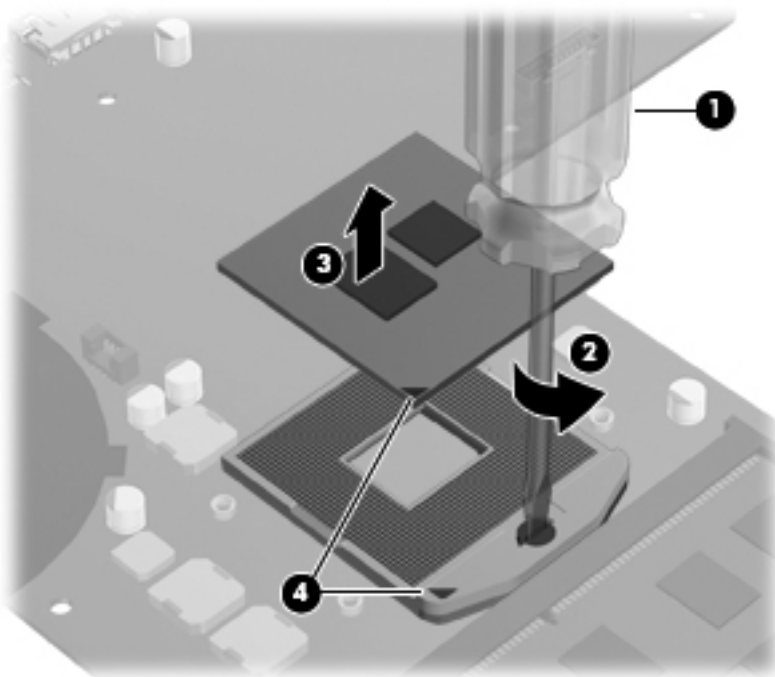

Reverse this procedure to install the processor.

## Display assembly

 **NOTE:** The display assembly spare part kit includes webcam, two microphones, and wireless antenna transceivers and cables).

Description	Spare part number
17.3-in, HD, LED, BrightView display assembly (includes webcam, two microphones, and wireless antenna transceivers and cables)	
In butter gold finish	640223-001
In charcoal gray finish	640226-001
In luminous rose finish	640225-001
In ocean drive finish	640224-001
In Pacific blue finish	640221-001
In pearl pink finish	640228-001
In pewter finish	640227-001
In Sonoma red finish	640220-001
In sweet purple finish	640222-001

Before removing the display assembly, follow these steps:

1. Shut down the computer. If you are unsure whether the computer is off or in Hibernation, turn the computer on, and then shut it down through the operating system.
2. Disconnect all external devices connected to the computer.
3. Disconnect the power from the computer by first unplugging the power cord from the AC outlet and then unplugging the AC adapter from the computer.
4. Remove the battery (see [Battery on page 47](#)), and then remove the following components:
  - Optical drive (see [Optical drive on page 49](#))
  - Hard drive (see [Hard drive on page 51](#))
  - WLAN module (see [WLAN module on page 55](#))
  - Keyboard (see [Keyboard on page 57](#))
  - Top cover (see [Top cover on page 61](#))

Remove the display assembly:

1. Disconnect the display panel cable **(1)** from the system board.
2. Release the wireless antenna cables **(2)** from the clips and the opening in the base enclosure.

---

**⚠ CAUTION:** Support the display assembly when removing the following screws. Failure to support the display assembly can result in damage to the display assembly and other computer components.

---

3. Remove the three Phillips PM2.5×6.0 screws **(3)** that secure the display assembly to the computer.
4. Remove the display assembly **(4)**.

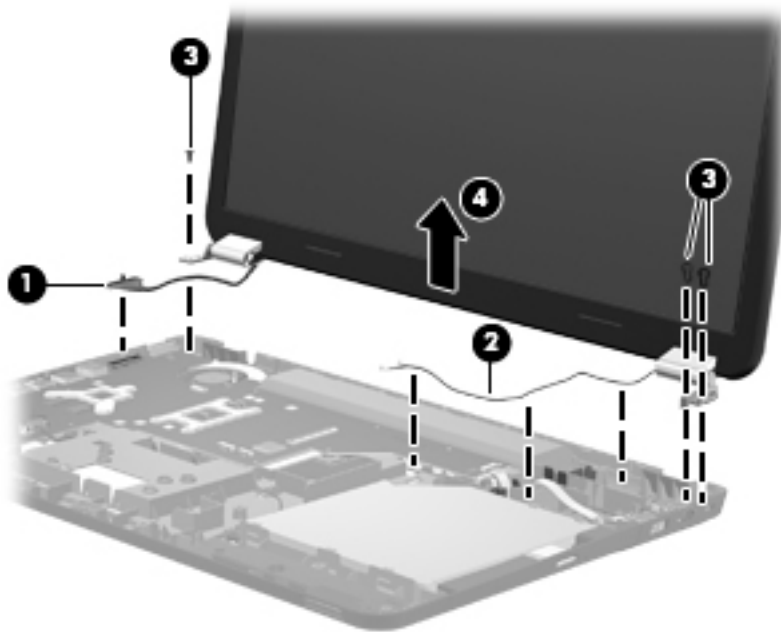

5. If it is necessary to replace the display bezel or any of the display assembly subcomponents:
- a. Remove the two crew covers **(1)** and the two Phillips PM2.5×6.0 screws **(2)** that secure the display bezel to the display assembly. The screw covers are available in the Display Screw Kit, spare part number 640218-001.

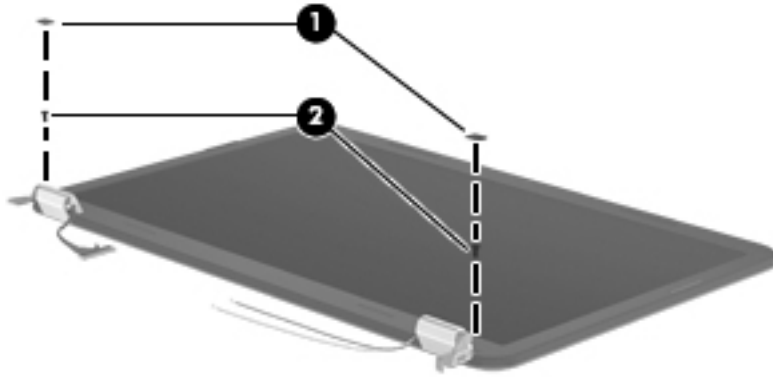

- b. Flex the inside edges of the top edge **(1)**, the left and right sides **(2)**, and the bottom edge **(3)** of the display bezel until the bezel disengages from the display enclosure.
- c. Remove the display bezel **(4)**. The display bezel is available using spare part number 640204-001.

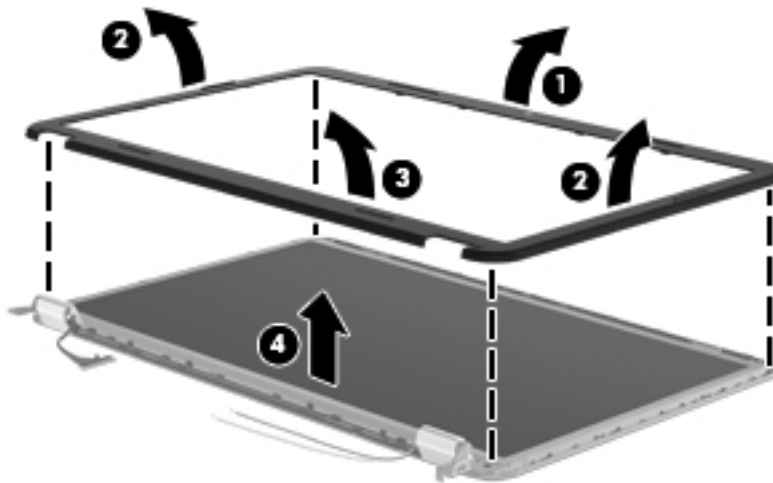

6. If it is necessary to replace the webcam/microphone module:
- a. Detach and release the webcam/microphone module **(1)** as far as the webcam/microphone module cable allows. (The webcam/microphone module is attached to the display enclosure with double-sided tape.)

- b.** Disconnect the webcam/microphone module **(2)** from the webcam/microphone module.

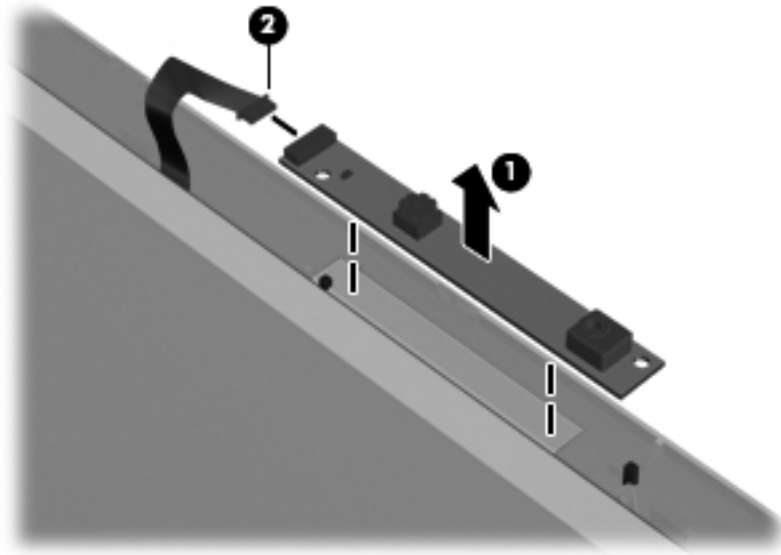

- c.** Remove the webcam/microphone module. The webcam/microphone module is available using spare part number 637197-001.

**7.** If it is necessary to replace the hinge covers:

- a.** Remove the two Phillips PM2.5×6.0 **(1)** screws that secure the hinge covers to the display enclosure.
- b.** Remove the hinge covers **(2)**. The hinge covers are available using spare part number 643698-001.

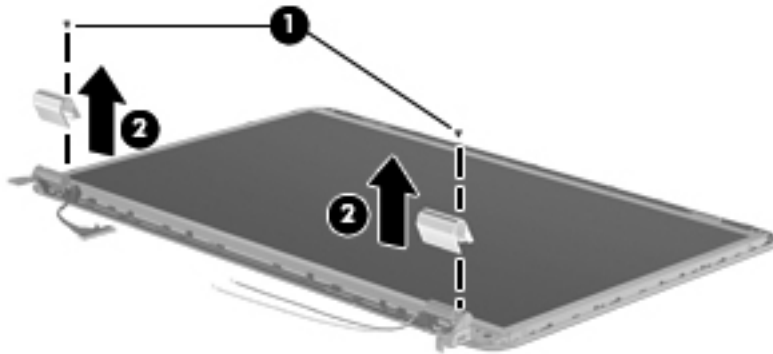



- 8.** If it is necessary to replace the display panel:
- a.** Remove the four Phillips PM2.5×6.0 screws that secure the display panel to the display enclosure.

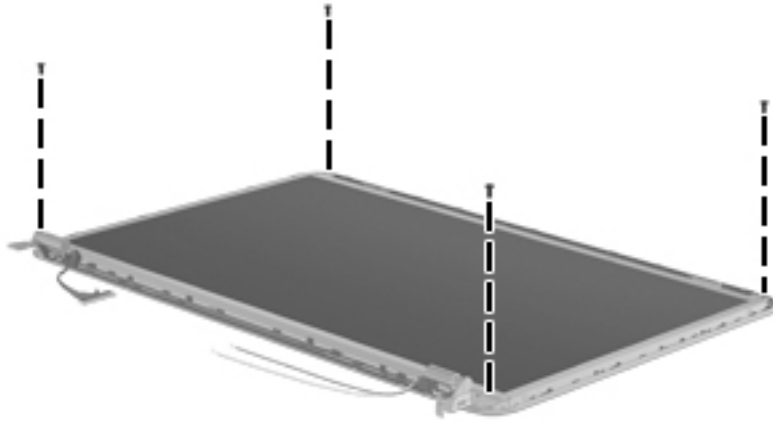

- b.** Lift the top edge of the display panel, and then swing it up and forward until it rests upside down in front of the display enclosure.

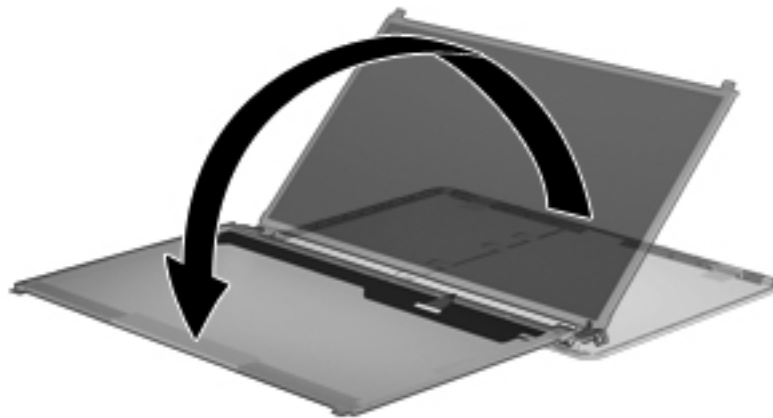

- c. Release the adhesive strip **(1)** that secures the display panel cable to the display panel, and then disconnect the display panel cable **(2)** from the display panel.

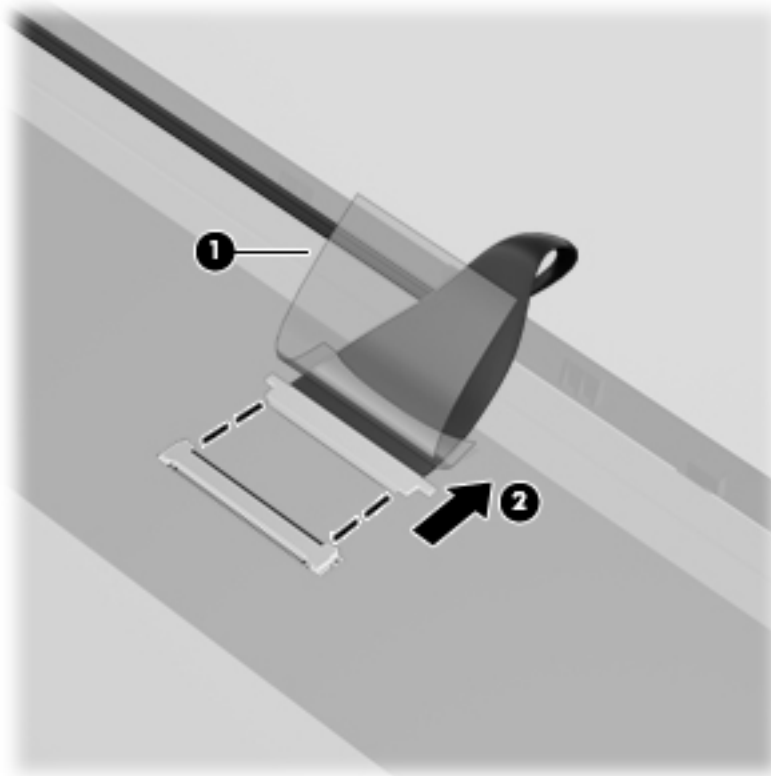

- d. Remove the display panel. The display panel is available using spare part number 641395-001.
9. If it is necessary to replace the display hinges:
- a. Remove the four Phillips PM2.0×3.0 screws **(1)** that secure the display hinges to the display panel.

- b. Remove the display hinges (**2**). The display hinges include the display hinges and brackets and are available using spare part number 640207-001.

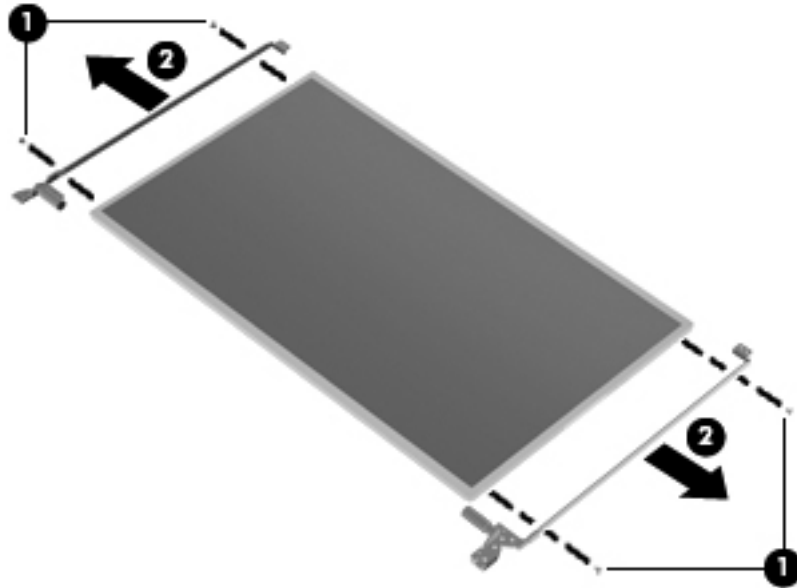

10. If it is necessary to replace the display panel cable:

- a. Release the tabs (**1**) built into the display enclosure shielding that secure the display panel cable to the display enclosure.
- b. Release the display panel cable from the clips (**2**) built into the display enclosure.
- c. Remove the display panel cable (**3**). The display panel cable includes the webcam/microphone module cable and is available in the Display Cable Kit, spare part number 640205-001.

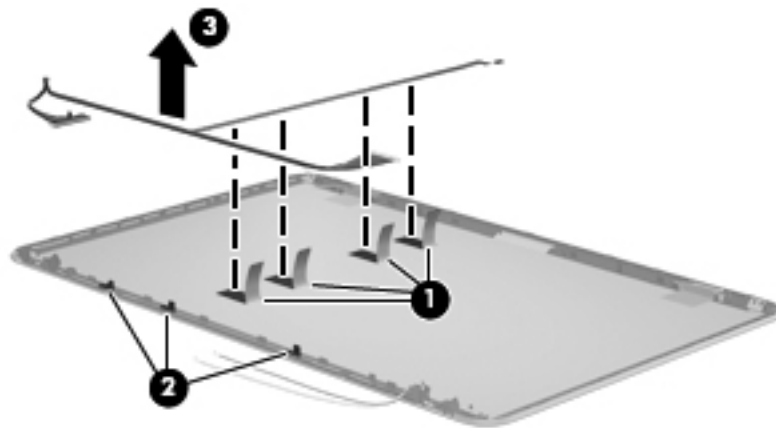

11. If it is necessary to replace the wireless antenna cables and transceivers:

- a. Release the wireless antenna transceivers (**1**) from the display enclosure. (The wireless antenna transceivers are attached to the display enclosure with double-sided tape.)
- b. Release the wireless antenna cables from the clips (**2**) built into the display enclosure.

- c. Remove the wireless antenna cables and transceivers **(3)**. The wireless antenna cables and transceivers are available in the Antenna Kit, spare part number 640192-001.

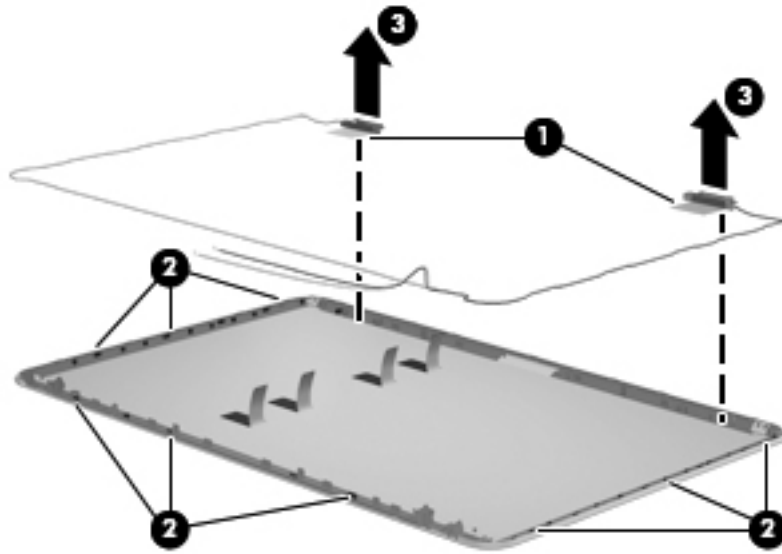

Reverse this procedure to reassemble and install the display assembly.

---

# 5 Setup Utility (BIOS) and System Diagnostics

## Using Setup Utility

Setup Utility, or Basic Input/Output System (BIOS), controls communication between all the input and output devices on the system (such as disk drives, display, keyboard, mouse, and printer). Setup Utility includes settings for the types of peripherals installed, the startup sequence of the computer, and the amount of system and extended memory.

 **NOTE:** Use extreme care when making changes in Setup Utility. Errors can prevent the computer from operating properly.

---

## Starting Setup Utility

 **NOTE:** An external keyboard or mouse connected to a USB port can be used with Setup Utility only if USB legacy support is enabled.

---

To start Setup Utility, follow these steps:

1. Turn on or restart the computer, and then press `esc` while the “Press the ESC key for Startup Menu” message is displayed at the bottom of the screen.
2. Press `f10` to enter Setup Utility.

## Changing the language of Setup Utility

1. Start Setup Utility.
2. Use the arrow keys to select **System Configuration > Language**, and then press `enter`.
3. Use the arrow keys to select a language, and then press `enter`.
4. When a confirmation prompt with your language selected is displayed, press `enter`.
5. To save your change and exit Setup Utility, use the arrow keys to select **Exit > Exit Saving Changes**, and then press `enter`.

Your change takes effect immediately.

## Navigating and selecting in Setup Utility

To navigate and select in Setup Utility, follow these steps:

1. Turn on or restart the computer, and then press **esc** while the “Press the ESC key for Startup Menu” message is displayed at the bottom of the screen.
  - To select a menu or a menu item, use the tab key and the keyboard arrow keys and then press **enter**, or use a pointing device to click the item.
  - To scroll up and down, click the up arrow or the down arrow in the upper-right corner of the screen, or use the up arrow key or the down arrow key.
  - To close open dialog boxes and return to the main Setup Utility screen, press **esc**, and then follow the on-screen instructions.



---

**NOTE:** You can use either a pointing device (TouchPad, pointing stick, or USB mouse) or the keyboard to navigate and make selections in Setup Utility.

---

2. Press **f10** to enter Setup Utility.

To exit Setup Utility menus, choose one of the following methods:

- To exit Setup Utility menus without saving your changes, click the **Exit** icon in the lower-left corner of the screen, and then follow the on-screen instructions.

– or –

Use the tab key and the arrow keys to select **File > Ignore Changes and Exit**, and then press **enter**.

- To save your changes and exit Setup Utility menus, click the **Save** icon in the lower-left corner of the screen, and then follow the on-screen instructions.

– or –

Use the tab key and the arrow keys to select **File > Save Changes and Exit**, and then press **enter**.

Your changes go into effect when the computer restarts.

## Displaying system information

1. Start Setup Utility.
2. Select the **Main** menu. System information such as the system time and date, and identification information about the computer is displayed.
3. To exit Setup Utility without changing any settings, use the arrow keys to select **Exit > Exit Discarding Changes**, and then press **enter**.

## Restoring factory settings in Setup Utility

---

 **NOTE:** Restoring defaults will not change the hard drive mode.

---

To return all settings in Setup Utility to the values that were set at the factory, follow these steps:

1. Turn on or restart the computer, and then press **esc** while the “Press the ESC key for Startup Menu” message is displayed at the bottom of the screen.
2. Press **f10** to enter Setup Utility.
3. Use a pointing device or the arrow keys to select **File > Restore Defaults**.
4. Follow the on-screen instructions.
5. To save your changes and exit, click the **Save** icon in the lower-left corner of the screen, and then follow the on-screen instructions.

– or –

Use the arrow keys to select **File > Save Changes and Exit**, and then press **enter**.

Your changes go into effect when the computer restarts.

---

 **NOTE:** Your password settings and security settings are not changed when you restore the factory settings.

---

## Exiting Setup Utility

- To exit Setup Utility and save your changes from the current session:  
If the Setup Utility menus are not visible, press **esc** to return to the menu display. Then use the arrow keys to select **Exit > Exit Saving Changes**, and then press **enter**.
- To exit Setup Utility without saving your changes from the current session:  
If the Setup Utility menus are not visible, press **esc** to return to the menu display. Then use the arrow keys to select **Exit > Exit Discarding Changes**, and then press **enter**.

## Updating the BIOS

Updated versions of the BIOS may be available on the HP Web site.

Most BIOS updates on the HP Web site are packaged in compressed files called *SoftPaqs*.

Some download packages contain a file named *Readme.txt*, which contains information regarding installing and troubleshooting the file.

## Determining the BIOS version

To determine whether available BIOS updates contain later BIOS versions than those currently installed on the computer, you need to know the version of the system BIOS currently installed.

BIOS version information (also known as ROM date and System BIOS) can be displayed by pressing **fn +esc** (if you are already in Windows) or by using Setup Utility.

1. Start Setup Utility.
2. Use a pointing device or the arrow keys to select **File > System Information**.
3. To exit Setup Utility without saving your changes, click the **Exit** icon in the lower-left corner of the screen, and then follow the on-screen instructions.

– or –

Use the tab key and the arrow keys to select **File > Ignore Changes and Exit**, and then press **enter**.

## Downloading a BIOS update

 **CAUTION:** To reduce the risk of damage to the computer or an unsuccessful installation, download and install a BIOS update only when the computer is connected to reliable external power using the AC adapter. Do not download or install a BIOS update while the computer is running on battery power, docked in an optional docking device, or connected to an optional power source. During the download and installation, follow these instructions:

Do not disconnect power from the computer by unplugging the power cord from the AC outlet.

Do not shut down the computer or initiate Sleep or Hibernation.

Do not insert, remove, connect, or disconnect any device, cable, or cord.

1. **Windows 7**—Select **Start > Help and Support > Maintain**.

**Windows XP**—Select **Start > Help and Support**, and then select the software and drivers update.

2. Follow the on-screen instructions to identify your computer and access the BIOS update you want to download.
3. At the download area, follow these steps:
  - a. Identify the BIOS update that is later than the BIOS version currently installed on your computer. Make a note of the date, name, or other identifier. You may need this information to locate the update later, after it has been downloaded to your hard drive.
  - b. Follow the on-screen instructions to download your selection to the hard drive. Make a note of the path to the location on your hard drive where the BIOS update is downloaded. You will need to access this path when you are ready to install the update.



**NOTE:** If you connect your computer to a network, consult the network administrator before installing any software updates, especially system BIOS updates.



BIOS installation procedures vary. Follow any instructions that are displayed on the screen after the download is complete. If no instructions are displayed, follow these steps:

1. **Windows 7**—Open Windows Explorer by selecting **Start > Computer**.  
**Windows XP**—Open Windows Explorer by selecting **Start > My Computer**.
2. Double-click your hard drive designation. The hard drive designation is typically Local Disk (C:).
3. Using the hard drive path you recorded earlier, open the folder on your hard drive that contains the update.
4. Double-click the file that has an .exe extension (for example, *filename.exe*).  
the BIOS installation begins.
5. Complete the installation by following the on-screen instructions.

---

 **NOTE:** After a message on the screen reports a successful installation, you can delete the downloaded file from your hard drive.

---

## Using System Diagnostics

System Diagnostics allows you to run diagnostic tests to determine if the computer hardware is functioning properly. The following diagnostic tests are available in System Diagnostics:

- Start-up test—This test analyzes the main computer components that are required to start the computer.
- Run-in test—This test repeats the start-up test and checks for intermittent problems that the start-up test does not detect.
- Hard disk test—This test analyzes the physical condition of the hard drive, and then checks all data in every sector of the hard drive. If the test detects a damaged sector, it attempts to move the data to a good sector.
- Memory test—This test analyzes the physical condition of the memory modules. If it reports an error, replace the memory modules immediately.
- Battery test—This test analyzes the condition of the battery. If the battery fails the test, contact HP support to report the issue and purchase a replacement battery.

You can also view system information and error logs in the System Diagnostics window.

To start System Diagnostics:

1. Turn on or restart the computer. While the “Press the ESC key for Startup Menu” message is displayed in the lower-left corner of the screen, press **esc**. When the Startup Menu is displayed, press **f2**.
2. Click the diagnostic test you want to run, and then follow the on-screen instructions.

---

 **NOTE:** If you need to stop a diagnostics test while it is running, press **esc**.

---

# 6 Specifications

## Computer specifications

	Metric	U.S.
<b>Dimensions</b>		
Depth	<b>26.8 cm</b>	10.6 in
Width	<b>41.2 cm</b>	16.2 in
Height	<b>3.1 to 3.7 cm</b>	1.2 to 1.5 in
<b>Weight</b>	<b>2.97 kg</b>	6.55 lb
<b>Input power</b>		
Operating voltage	18.5 V dc @ 3.5 A -65 W or 19.0 V dc @ 4.74 A -90 W	
Operating current	3.5 or 4.74 A	
<b>Temperature</b>		
Operating	<b>5°C to 35°C</b>	41°F to 95°F
Nonoperating	<b>-20°C to 60°C</b>	-4°F to 140°F
<b>Relative humidity</b> (noncondensing)		
Operating	10% to 90%	
Nonoperating	5% to 95%	
<b>Maximum altitude</b> (unpressurized)		
Operating	<b>-15 m to 3,048 m</b>	-50 ft to 10,000 ft
Nonoperating	<b>-15 m to 12,192 m</b>	-50 ft to 40,000 ft
<b>NOTE:</b> Applicable product safety standards specify thermal limits for plastic surfaces. The device operates well within this range of temperatures.		

## 17.3-inch display specifications

	<b>Metric</b>	<b>U.S.</b>
<b>Dimensions</b>		
Height	<b>21.7 cm</b>	8.54 in
Width	<b>38.4 cm</b>	15.12 in
Diagonal	<b>43.9 cm</b>	17.29 in
<b>Number of colors</b>	Up to 16.8 million	
<b>Contrast ratio</b>	200:1 (typical)	
<b>Brightness</b>	180 nits (typical)	
<b>Pixel resolution</b>		
Pitch	<b>0.197 × 0.197 mm</b>	
Format	1600 × 900	
Configuration	RGB vertical stripe	
<b>Backlight</b>	LED	
<b>Character display</b>	80 × 25	
<b>Total power consumption</b> (varies by display)	2.0 W	
<b>Viewing angle</b>	±65° horizontal, ±50° vertical (typical)	

# Hard drive specifications

	750-GB*	640-GB*	500-GB*	320-GB*	250-GB*
<b>Dimensions</b>					
Height	9.5 mm	9.5 mm	9.5 mm	9.5 and 7.0 mm	7.0 mm
Length	100.2 mm	100.2 mm	100.4 mm	100.4 mm	100.4 mm
Width	69.9 mm	69.9 mm	69.9 mm	69.9 mm	69.9 mm
Weight	110 g	98 g	110 g	110 g	110 g
<b>Interface type</b>	SATA (3 GB/sec)	SATA (3 GB/sec)	SATA	SATA	SATA
<b>Transfer rate</b>					
Synchronous (maximum)	97 MB/sec	106 MB/sec	1.1 GB/sec	1.1 GB/sec	1.1 GB/sec
Security	ATA security	ATA security	ATA security	ATA security	ATA security
<b>Seek times</b> (typical read, including setting)					
Single track	2.0 ms	1.5 ms	1.5 ms	1.5 ms	1.5 ms
Average (read/write)	12/16 ms	12/13 ms	11/13 ms	11/13 ms	11/13 ms
Maximum	21 ms	24 ms	22 ms	22 ms	22 ms
<b>Logical blocks</b>	1,465,149,168	1,250,263,728	976,773,168	628,142,448	488,397,168
<b>Disk rotational speed</b>	5400 rpm	5400 rpm	7200 and 5400 rpm	7200 and 5400 rpm	7200 and 5400 rpm
<b>Operating temperature</b>	0°C to 60°C (32°F to 140°F)				
*1 GB = 1 billion bytes when referring to hard drive storage capacity. Actual accessible capacity is less.					
<b>NOTE:</b> Certain restrictions and exclusions apply. Contact technical support for details.					

---

# 7 Backup and recovery

Your computer includes tools provided by the operating system and HP to help you safeguard your information and restore it if ever needed.

This chapter provides information on the following topics:

- Creating a set of recovery discs or a recovery flash drive (Recovery Manager software feature)
- Performing a system restore (from the partition, recovery discs, or a recovery flash drive)
- Backing up your information
- Recovering a program or driver

## Restore

In the event of hard drive failure, to restore your system to its factory image you will need a set of recovery discs or a recovery flash drive that you can create using HP Recovery Manager. HP recommends that you use this software to create either a set of recovery discs or a recovery flash drive immediately after software setup.

If for some other reason you need to restore your system, this can be achieved using the HP Recovery partition (select models only), without the need for recovery discs or a recovery flash drive. To check for the presence of a recovery partition, click **Start**, right-click **Computer**, click **Manage**, and then click **Disk Management**. If the recovery partition is present, a Recovery drive is listed in the window.

---

 **CAUTION:** HP Recovery Manager (partition, or discs/flash drive) restores only software that was preinstalled at the factory. Software not provided with this computer must be reinstalled manually.

 **NOTE:** Recovery discs have been included if your computer does not have a recovery partition.

---

# Creating restore media

HP recommends that you create either a set of recovery discs or a recovery flash drive to be sure that you can restore your computer to its original factory state if the hard drive fails, or if for any reason you cannot restore using the recovery partition tools. Create these discs or the flash drive after setting up the computer for the first time.

---

 **NOTE:** HP Recovery Manager allows the creation of only one set of recovery discs or one recovery flash drive. Handle these discs or flash drive carefully and keep them in a safe place.

 **NOTE:** If your computer does not include an integrated optical drive, you can use an optional external optical drive (purchased separately) to create recovery discs, or you can purchase recovery discs for your computer from the HP Web site. If you use an external optical drive, it must be connected directly to a USB port on the computer, not to a USB port on an external device, such as a USB hub.

---

Guidelines:

- Purchase high-quality DVD-R, DVD+R, DVD-R DL, or DVD+R DL discs.

---

 **NOTE:** Read-write discs, such as CD-RW, DVD±RW, double-layer DVD±RW, and BD-RE (rewritable Blu-ray) discs, are not compatible with the Recovery Manager software.

---

- the computer must be connected to AC power during this process.
- Only one set of recovery discs or one recovery flash drive can be created per computer.

---

 **NOTE:** If you are creating recovery discs, number each disc before inserting into the optical drive.

---

- If necessary, you can exit the program before you have finished creating the recovery discs or recovery flash drive. The next time you open Recovery Manager, you will be prompted to continue the backup creation process.

To create a set of recovery discs or a recovery flash drive:

1. Select **Start > All Programs > Recovery Manager > Recovery Media Creation**.
2. Follow the on-screen instructions.

# Performing a system restore

Recovery Manager software allows you to repair or restore the computer to its original factory state. Recovery Manager works from recovery discs, a recovery flash drive, or from a dedicated recovery partition (select models only) on the hard drive.

 **NOTE:** A system restore needs to be performed if the computer hard drive has failed or if all attempts to correct any functional computer issues fail.

A system restore should be used as a final attempt to correct computer issues. Note the following when performing a system restore:

- You can restore only the system that you have previously backed up. HP recommends that you use HP Recovery Manager to create either a set of recovery discs or a recovery flash drive as soon as you set up the computer.
- Windows has its own built-in repair features, such as System Restore. If you have not already tried these features, try them before using Recovery Manager.
- Recovery Manager restores only software that was preinstalled at the factory. Software not provided with this computer must be downloaded from the manufacturer's Web site or reinstalled from the disc provided by the manufacturer.

## Restoring using the dedicated recovery partition (select models only)

When using the dedicated recovery partition, there is an option to back up pictures, music and other audio, videos and movies, recorded TV shows, documents, spreadsheets and presentations, e-mails, Internet favorites and settings during this process.

To restore the computer from the recovery partition, follow these steps:

1. Access Recovery Manager in either of the following ways:
  - Select **Start > All Programs > Recovery Manager > Recovery Manager**.
  - or –
  - Turn on or restart the computer, and then press **esc** while the “Press the ESC key for Startup Menu” message is displayed at the bottom of the screen. Then, press **f11** while the “F11 (System Recovery)” message is displayed on the screen.
2. Click **System Recovery** in the **Recovery Manager** window.
3. Follow the on-screen instructions.

## Restoring using the restore media

1. If possible, back up all personal files.
2. Insert the first recovery disc into the optical drive on your computer or an optional external optical drive, and then restart the computer.

– or –

Insert the recovery flash drive into a USB port on your computer, and then restart the computer.



---

**NOTE:** If the computer does not automatically restart in the Recovery Manager, the computer boot order needs to be changed.

---

3. Press **f9** at system bootup.
4. Select the optical drive or the flash drive.
5. Follow the on-screen instructions.

## Changing the computer boot order

To change the boot order for recovery discs:

1. Restart the computer.
2. Press **esc** while the computer is restarting, and then press **f9** for boot options.
3. Select **Internal CD/DVD ROM Drive** from the boot options window.

To change the boot order for recovery flash drive:

1. Insert the flash drive into a USB port.
2. Restart the computer.
3. Press **esc** while the computer is restarting, and then press **f9** for boot options.
4. Select the flash drive from the boot options window.



# Backing up and recovering your information

It is very important to back up your files and keep any new software in a safe place. As you add new software and data files, continue to create backups on a regular basis.

How completely you are able to recover your system depends on how recent your backup is.



**NOTE:** A recovery from your most recent backup needs to be performed if the computer has a virus attack or if any major system components fail. In order to correct computer issues, a recovery should first be attempted before a system restore is attempted.

You can back up your information to an optional external hard drive, a network drive, or discs. Back up your system at the following times:

- At regularly scheduled times



**TIP:** Set reminders to back up your information periodically.

- Before the computer is repaired or restored
- Before you add or modify hardware or software

Guidelines:

- Create system restore points using the Windows System Restore feature, and periodically copy them to an optical disc or an external hard drive. For more information on using system restore points, refer to **Using Windows system restore points**.
- Store personal files in the Documents library and back up this folder periodically.
- Save customized settings in a window, toolbar, or menu bar by taking a screen shot of your settings. The screen shot can be a time-saver if you have to re-enter your preferences.

To create a screen shot:

1. Display the screen you want to save.
2. Copy the screen image:  
To copy only the active window, press **alt+fn+prt sc**.  
To copy the entire screen, press **fn+prt sc**.
3. Open a word-processing document, and then select **Edit > Paste**. The screen image is added to the document.
4. Save and print the document.

## Using Windows Backup and Restore

Guidelines:

- Be sure that the computer is connected to AC power before you start the backup process.
- Allow enough time to complete the backup process. Depending on file sizes, it may take over an hour.

To create a backup:

1. Select **Start > Control Panel > System and Security > Backup and Restore**.
2. Follow the on-screen instructions to schedule and create a backup.



---

**NOTE:** Windows includes the User Account Control feature to improve the security of the computer. You may be prompted for your permission or password for tasks such as installing software, running utilities, or changing Windows settings. Refer to Help and Support for more information.

---

## Using Windows system restore points

A system restore point allows you to save and name a snapshot of your hard drive at a specific point in time. You can then recover back to that point if you want to reverse subsequent changes.



---

**NOTE:** Recovering to an earlier restore point does not affect data files saved or e-mails created since the last restore point.

---

You also can create additional restore points to provide increased protection for your files and settings.

## When to create restore points

- Before you add or modify software or hardware
- Periodically, whenever the computer is functioning optimally



---

**NOTE:** If you revert to a restore point and then change your mind, you can reverse the restoration.

---

## Create a system restore point

1. Select **Start > Control Panel > System and Security > System**.
2. In the left pane, click **System Protection**.
3. Click the **System Protection** tab.
4. Follow the on-screen instructions.

## Restore to a previous date and time

To revert to a restore point (created at a previous date and time), when the computer was functioning optimally, follow these steps:

1. Select **Start > Control Panel > System and Security > System**.
2. In the left pane, click **System Protection**.
3. Click the **System Protection** tab.
4. Click **System Restore**.
5. Follow the on-screen instructions.

---

## 8 Power cord set requirements

the wide-range input feature of the computer permits it to operate from any line voltage from 100 to 120 volts AC, or from 220 to 240 volts AC

the 3-conductor power cord set included with the computer meets the requirements for use in the country or region where the equipment is purchased.

Power cord sets for use in other countries and regions must meet the requirements of the country or region where the computer is used.

### Requirements for all countries

the following requirements are applicable to all countries and regions:

- the length of the power cord set must be at least **1.5 m** (5.0 ft) and no more than **2.0 m** (6.5 ft).
- All power cord sets must be approved by an acceptable accredited agency responsible for evaluation in the country or region where the power cord set will be used.
- the power cord sets must have a minimum current capacity of 10 amps and a nominal voltage rating of 125 or 250 V AC, as required by the power system of each country or region.
- the appliance coupler must meet the mechanical configuration of an EN 60 320/IEC 320 Standard Sheet C13 connector for mating with the appliance inlet on the back of the computer.

## Requirements for specific countries and regions

Country/region	Accredited agency	Applicable note number
Australia	EANSW	1
Austria	OVE	1
Belgium	CEBC	1
Canada	CSA	2
Denmark	DEMKO	1
Finland	FIMKO	1
France	UTE	1
Germany	VDE	1
Italy	IMQ	1
Japan	METI	3
the Netherlands	KEMA	1
Norway	NEMKO	1
the People's Republic of China	COC	5
South Korea	EK	4
Sweden	SEMKO	1
Switzerland	SEV	1
Taiwan	BSMI	4
the United Kingdom	BSI	1
the United States	UL	2

1. the flexible cord must be Type HO5VV-F, 3-conductor, 1.0-mm<sup>2</sup> conductor size. Power cord set fittings (appliance coupler and wall plug) must bear the certification mark of the agency responsible for evaluation in the country or region where it will be used.
2. the flexible cord must be Type SPT-3 or equivalent, No. 18 AWG, 3-conductor. The wall plug must be a two-pole grounding type with a NEMA 5-15P (15 A, 125 V) or NEMA 6-15P (15 A, 250 V) configuration.
3. the appliance coupler, flexible cord, and wall plug must bear a "T" mark and registration number in accordance with the Japanese Dentori Law. The flexible cord must be Type VCT or VCTF, 3-conductor, 1.00-mm<sup>2</sup> conductor size. The wall plug must be a two-pole grounding type with a Japanese Industrial Standard C8303 (7 A, 125 V) configuration.
4. the flexible cord must be Type RVV, 3-conductor, 0.75-mm<sup>2</sup> conductor size. Power cord set fittings (appliance coupler and wall plug) must bear the certification mark of the agency responsible for evaluation in the country or region where it will be used.
5. the flexible cord must be Type VCTF, 3-conductor, 0.75-mm<sup>2</sup> conductor size. Power cord set fittings (appliance coupler and wall plug) must bear the certification mark of the agency responsible for evaluation in the country or region where it will be used.

---

# 9 Recycling

## Battery

When a battery has reached the end of its useful life, do not dispose of the battery in general household waste. Follow the local laws and regulations in your area for computer battery disposal.

## Display

---

**⚠ WARNING!** the backlight contains mercury. Caution must be exercised when removing and handling the backlight to avoid damaging this component and causing exposure to the mercury.

**⚠ CAUTION:** the procedures in this chapter can result in damage to display components. The only components intended for recycling purposes are the liquid crystal display (LCD) panel and the backlight. When you remove these components, handle them carefully.

**📄 NOTE:** Materials Disposal. This HP product contains mercury in the backlight in the display assembly that might require special handling at end-of-life. Disposal of mercury may be regulated because of environmental considerations. For disposal or recycling information, contact your local authorities, or see the Electronic Industries Alliance (EIA) Web site at <http://www.eiai.org>.

---

This section provides disassembly instructions for the display assembly. The display assembly must be disassembled to gain access to the backlight **(1)** and the liquid crystal display (LCD) panel **(2)**.



---

**📄 NOTE:** the procedures provided in this chapter are general disassembly instructions. Specific details, such as screw sizes, quantities, and locations, and component shapes and sizes, can vary from one computer model to another.

---

Perform the following steps:

1. Remove all screw covers **(1)** and screws **(2)** that secure the display bezel to the display assembly.

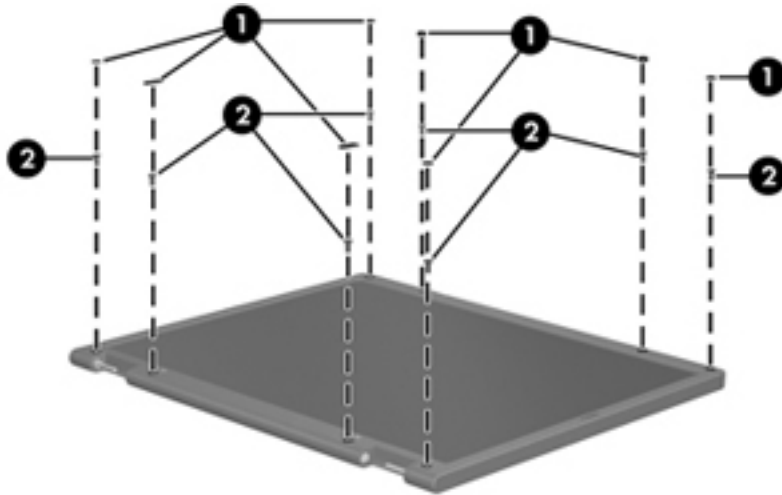

2. Lift up and out on the left and right inside edges **(1)** and the top and bottom inside edges **(2)** of the display bezel until the bezel disengages from the display assembly.
3. Remove the display bezel **(3)**.

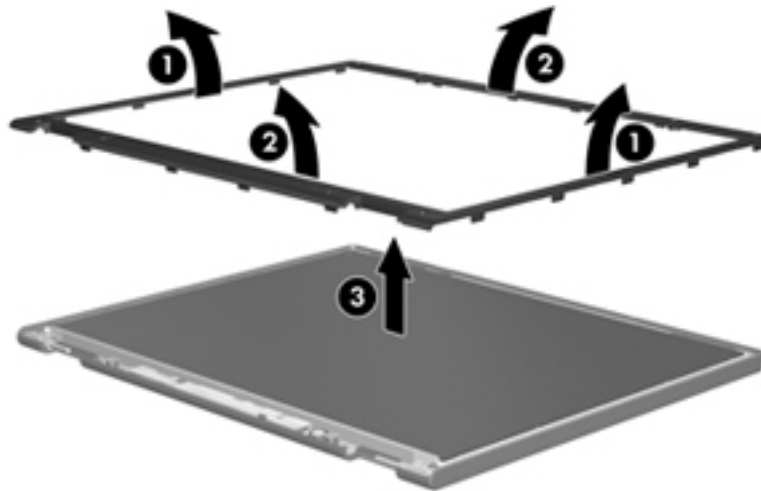

4. Disconnect all display panel cables (1) from the display inverter and remove the inverter 2.

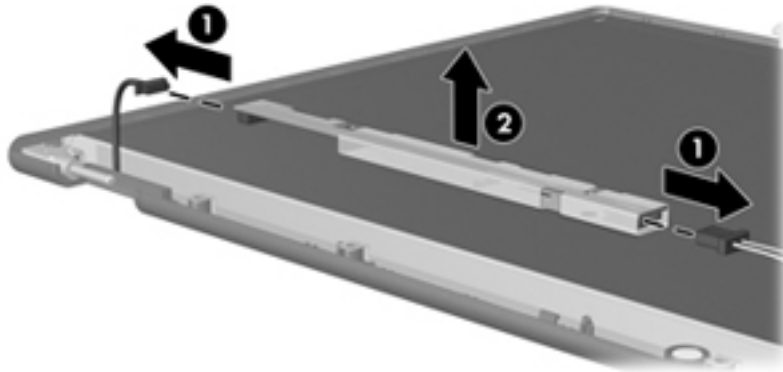

5. Remove all screws (1) that secure the display panel assembly to the display enclosure.
6. Remove the display panel assembly (2) from the display enclosure.

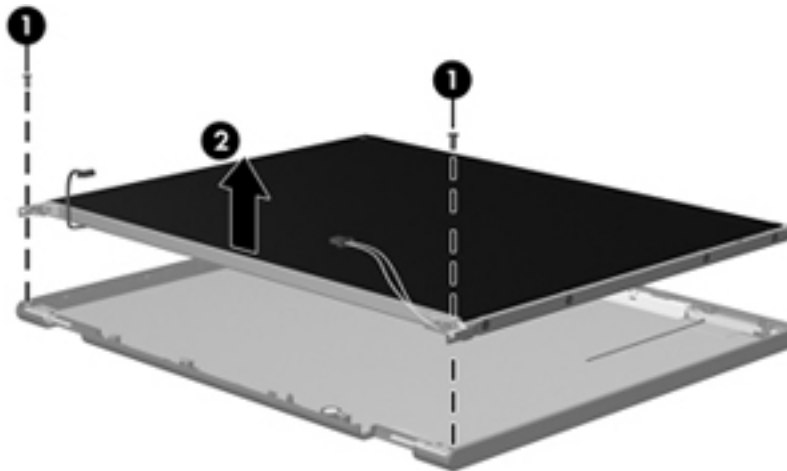

7. Turn the display panel assembly upside down.
8. Remove all screws that secure the display panel frame to the display panel.

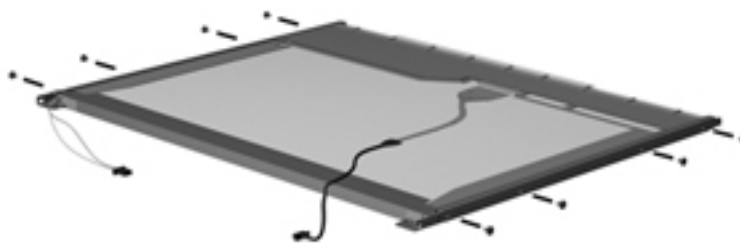

9. Use a sharp-edged tool to cut the tape (1) that secures the sides of the display panel to the display panel frame.



**10.** Remove the display panel frame **(2)** from the display panel.

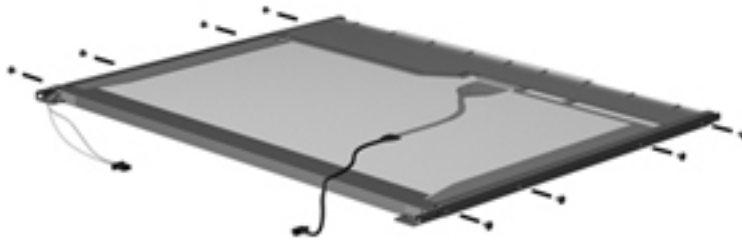

**11.** Remove the screws **(1)** that secure the backlight cover to the display panel.

**12.** Lift the top edge of the backlight cover **(2)** and swing it outward.

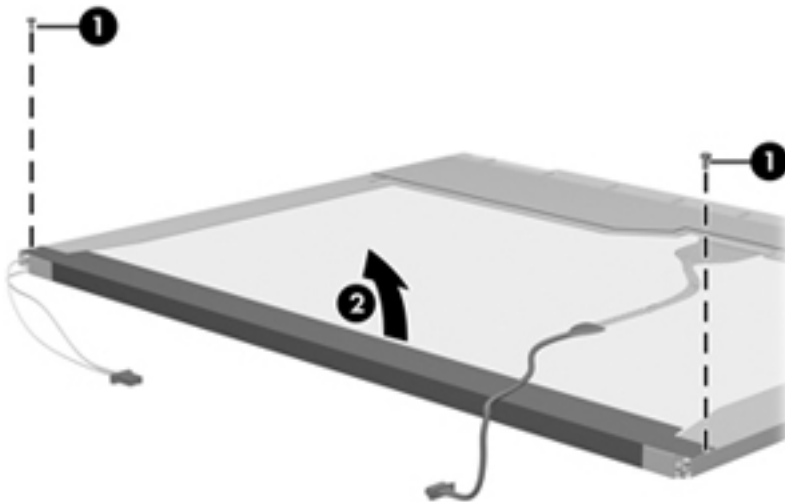

**13.** Remove the backlight cover.

**14.** Turn the display panel right-side up.

**15.** Remove the backlight cables **(1)** from the clip **(2)** in the display panel.

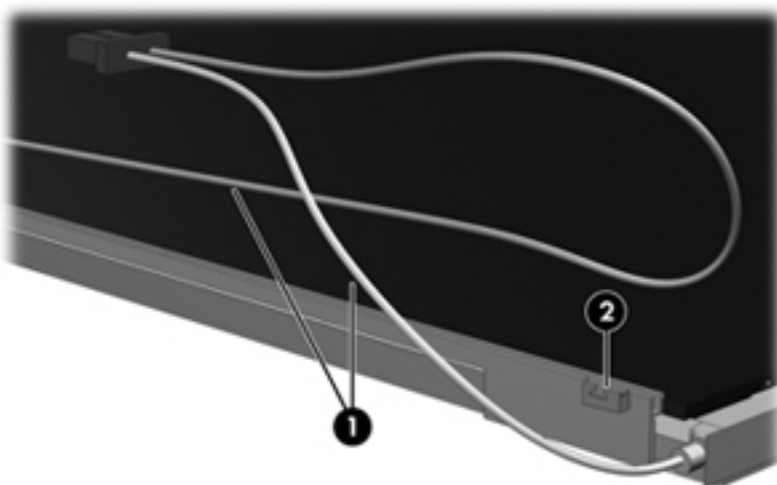

**16.** Turn the display panel upside down.

17. Remove the backlight frame from the display panel.

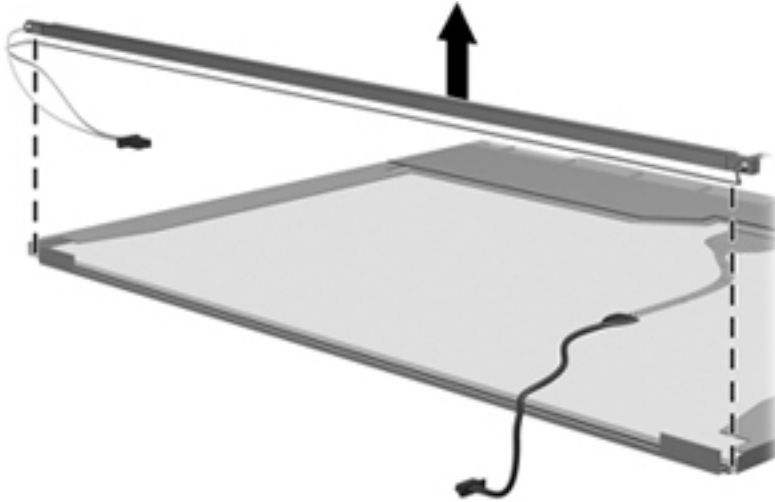

**⚠ WARNING!** the backlight contains mercury. Exercise caution when removing and handling the backlight to avoid damaging this component and causing exposure to the mercury.

18. Remove the backlight from the backlight frame.

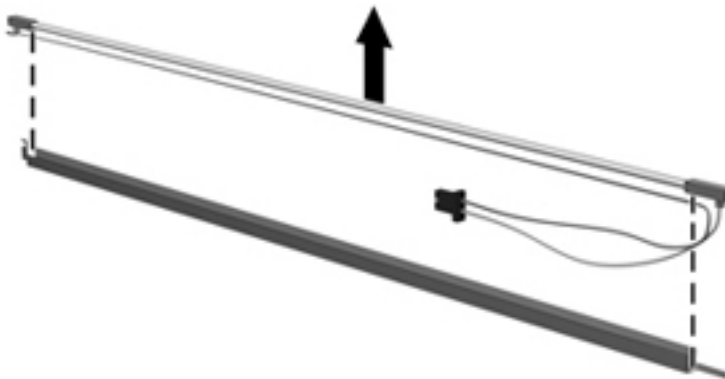

19. Disconnect the display cable **(1)** from the LCD panel.
20. Remove the screws **(2)** that secure the LCD panel to the display rear panel.
21. Release the LCD panel **(3)** from the display rear panel.

**22.** Release the tape **(4)** that secures the LCD panel to the display rear panel.

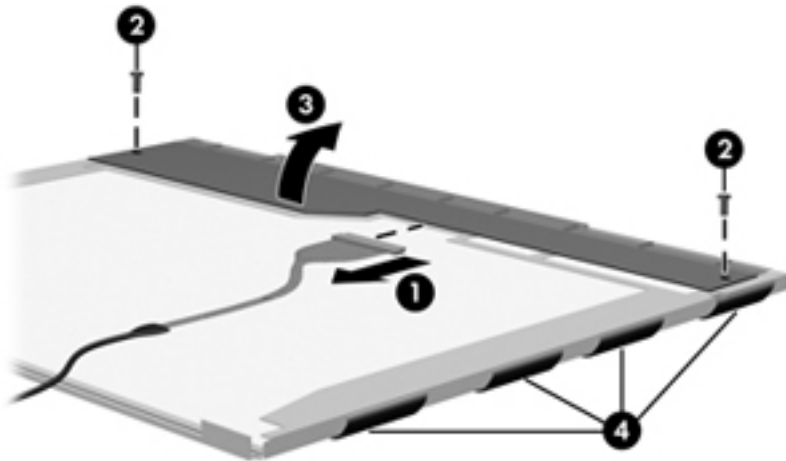

**23.** Remove the LCD panel.

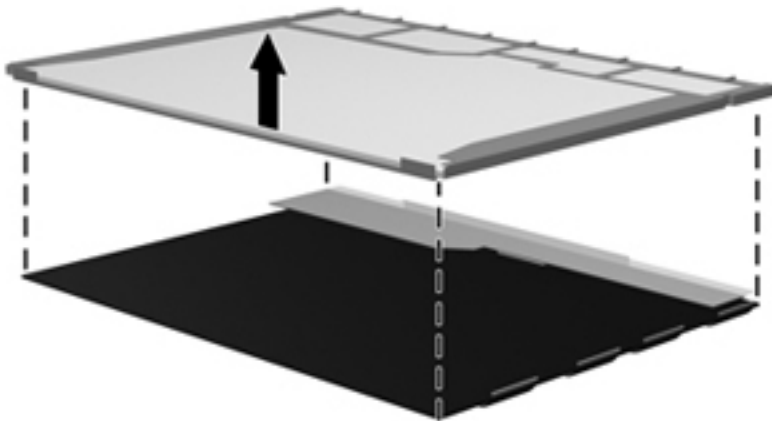

**24.** Recycle the LCD panel and backlight.

---

# Index

- A**
- AC adapter light 16
- AC adapter, spare part numbers 31, 32
- Action keys 11
- antenna
  - locations 14
  - removal 99
  - spare part number 28, 35, 100
- Antenna Kit, spare part number 28, 35, 100
- audio, product description 5
- audio-in jack 15
- audio-out jack 15
- B**
- base enclosure, spare part number 25, 35
- battery
  - removal 47
  - spare part numbers 25, 32, 47
- battery bay 17
- battery release latch 17
- Blu-ray ROM with LightScribe DVD  $\pm$ R/RW Super Multi Double-Layer Drive
  - precautions 42
  - removal 49
  - spare part numbers 49
- Blu-ray ROM with LightScribe DVD  $\pm$ R/RW Super Multi Double-Layer Drive
  - spare part number 26, 36
  - spare part numbers 30, 40
- Bluetooth module
  - removal 69
  - spare part number 22, 32, 69
- Bluetooth module cable
  - removal 70
  - spare part number 22, 32, 69
- bottom components 17
- button components 10
- buttons
  - optical drive eject 16
  - power 10
  - TouchPad 13
  - TouchPad on/off 13
- C**
- Cable Kit
  - contents 27
  - spare part number 22, 27, 35
- cables, service considerations 41
- caps lock light 12
- chipset, product description 3
- components
  - bottom 17
  - button 10
  - display 14
  - front 15
  - keys 11
  - left-side 15
  - lights 12
  - right-side 16
  - TouchPad 13
- computer feet
  - locations 47
  - spare part number 25, 35, 47
- computer major components 19
- computer specifications 106
- connectors, service considerations 41
- D**
- Digital Media Slot 16
- display
  - components 14
  - specifications 107
  - subcomponents 28
- display assembly
  - removal 93
  - spare part numbers 20, 36, 37, 93
- display bezel
  - removal 95
  - spare part number 28, 35
- Display Cable Kit, spare part number 28, 35, 99
- display enclosure, spare part numbers 29, 35, 95
- Display Hinge Kit, spare part number 28, 35, 99
- display panel
  - product description 4
  - removal 97
  - spare part number 28, 37, 98
- display panel cable
  - removal 99
  - spare part number 28, 35, 99
- Display Screw Kit, spare part number 29, 36
- drive light 16
- drives, preventing damage 42
- DVD $\pm$ RW and CD-RW Super Multi Double-Layer Combo Drive
  - spare part numbers 40
- DVD $\pm$ RW and CD-RW Super Multi Double-Layer Combo Drive with LightScribe
  - precautions 42
  - removal 49
  - spare part number 26, 36
  - spare part numbers 31, 49

## E

electrostatic discharge 42  
equipment guidelines 45  
esc key 11  
Ethernet, product description 5  
external media cards, product description 6  
external monitor port 15

## F

fan  
removal 83  
spare part number 25, 35, 83  
feet  
locations 47  
spare part number 25, 35, 47  
fn key 11  
front component 15

## G

graphics, product description 3  
grounding guidelines 42  
guidelines  
equipment 45  
grounding 42  
packaging 44  
transporting 44  
workstation 44

## H

hard drive  
precautions 42  
product description 5  
removal 51  
spare part numbers 26, 30, 34, 37, 38, 51  
specifications 108  
hard drive bay 17  
hard drive connector cable  
illustrated 27  
removal 52  
Hard Drive Hardware Kit, spare part number 26, 30, 35, 51  
hard drive isolator  
illustrated 30  
removal 52  
HDMI port 15  
headphone jack 15

## heat sink

removal 83  
spare part numbers 25, 35, 37, 39, 40, 83

## hinge

removal 98  
spare part number 28, 35, 99

## hinge cover

removal 96  
spare part number 28, 37, 96

## J

### jacks

audio-in 15  
audio-out 15  
headphone 15  
microphone 15  
network 15  
RJ-45 15

## K

key components 11  
keyboard  
product description 7  
removal 57  
spare part numbers 20, 35, 36, 38, 57  
keys  
Action 11  
esc 11  
fn 11  
numeric keypad 11  
Windows applications 11  
Windows logo 11

## L

LED board  
removal 72  
spare part number 25, 36, 72  
left-side components 15  
light components 12  
lights  
AC adapter 16  
caps lock 12  
drive 16  
optical drive 16  
power 12, 16  
TouchPad 12, 13  
webcam 14  
wireless 12

## M

mass storage device  
precautions 42  
removal 51  
spare part numbers 30, 51  
memory module  
product description 4  
removal 54  
spare part numbers 26, 33, 35, 54  
microphone  
location 14  
product description 5  
microphone jack 15  
model name 1  
monitor port 15

## N

network jack 15  
numeric keypad 11

## O

operating system, product description 7  
optical drive  
location 16  
precautions 42  
product description 5  
removal 49  
spare part numbers 26, 30, 36, 40, 49  
optical drive bay space saver,  
spare part number 26, 31, 40, 49  
optical drive bracket, removal 50  
optical drive cable  
illustrated 27  
removal 81  
optical drive eject button 16  
optical drive light 16

## P

packaging guidelines 44  
plastic parts, service considerations 41  
Plastics Kit, spare part number 27, 36, 49  
pointing device, product description 7  
ports  
external monitor 15

- HDMI 15
- monitor port 15
- product description 7
- USB 15, 16
- power button 10
- power button board
  - removal 64
  - spare part number 22, 36, 64
- power connector 16
- power connector cable
  - removal 75
  - spare part number 22, 37
- power cord
  - requirements for all countries 116
  - requirements for specific countries and regions 117
  - set requirements 116
  - spare part numbers 31, 32
- power light 12, 16
- power requirements, product description 7
- processor
  - product description 1
  - removal 90
  - spare part numbers 23, 33, 34, 39, 90
- product description
  - audio 5
  - chipset 3
  - display panel 4
  - Ethernet 5
  - external media cards 6
  - graphics 3
  - hard drives 5
  - keyboard 7
  - memory module 4
  - microphone 5
  - operating system 7
  - optical drive 5
  - pointing device 7
  - ports 7
  - power requirements 7
  - processors 1
  - product name 1
  - security 7
  - serviceability 8
  - video 5
  - wireless 5
- product name 1

**R**

- recycling
  - battery 118
  - display 118
- removal/replacement
  - preliminaries 41
  - procedures 46
- right-side components 16
- RJ-45 jack 15
- RTC battery
  - removal 53
  - spare part number 26, 34, 53
- Rubber Feet Kit, spare part number 25, 35, 47

**S**

- Screw Kit, spare part number 31, 36
- security cable slot 16
- security, product description 7
- service considerations
  - cables 41
  - connectors 41
  - plastic parts 41
- service cover
  - removal 49
  - spare part number 27, 49
- service tag 18, 46
- serviceability, product description 8
- Setup Utility (BIOS) 101
- Speaker Kit, spare part number 22, 37, 71
- speakers
  - locations 15
  - removal 71
  - spare part number 22, 37, 71
- specifications
  - computer 106
  - display 107
  - hard drive 108
- system board
  - removal 77
  - spare part numbers 22, 34, 35, 38, 39, 40, 77
- System Diagnostics 101

**T**

- Thermal Material Kit, spare part number 23, 33

- tools required 41
- top cover
  - removal 61
  - spare part numbers 21, 35, 37, 61
- TouchPad button 13
- TouchPad button board
  - removal 66
  - spare part number 22, 36, 66
- TouchPad cable
  - disconnection 62
  - illustrated 27
- TouchPad components 13
- TouchPad LED board
  - removal 67
  - spare part number 22, 36, 67
- TouchPad light 12, 13
- TouchPad on/off button 13
- TouchPad zone 13
- transporting guidelines 44

**U**

- USB board
  - removal 74
  - spare part number 22, 36
- USB port 15, 16

**V**

- vents 15, 17
- video, product description 5

**W**

- webcam 14
- webcam light 14
- webcam/microphone module
  - removal 95
  - spare part number 28, 34, 96
- Windows applications key 11
- Windows logo key 11
- wireless antenna
  - locations 14
  - removal 99
  - spare part number 28, 35, 100
- wireless light 12
- wireless, product description 5
- WLAN module
  - removal 55
  - spare part numbers 26, 32, 33, 37, 40, 55
- workstation guidelines 44